



Product range

Overview of all systems





Contents

More with MEVA	4	Triplex	28	KLK climbing scaffold	52
AluFix	6	MevaDec	30	MGC-H rail-guided climbing system	54
AluStar	8	MevaFlex	32	MGS-H rail-guided screen system	56
StarTec	10	VarioMax	34	MAC automatic climbing system	58
StarTec XT	12	MEVA FormSet	36	Special formwork design	60
Mammut 350	14	MT 60 shoring tower	38	Services & consulting	62
Mammut XT	16	MEP shoring tower	40	BIM, design & planning	64
MIS – MEVA Integrated Safety	18	SecuritBasic	42	Digital tools & architectural concrete	66
Radius circular formwork	20	BKB foldable pouring platform	44	Rental service & maintenance of customer formwork	68
Circo circular column formwork	22	KAB foldable working platform	46		
CaroFalt column formwork	24	MTT stair tower	48		
Support frame	26	Space	50		

*Formwork.
Simple. Smart.*



Pioneer and trendsetter

More with MEVA

Formwork. Simple. Smart.

A lot of things that are now considered to be standard in the formwork industry were developed by MEVA in Haiterbach. As a trendsetter for the entire industry, we work day in and day out with great élan to make formwork even safer, more efficient and easier to use for the end user. For us, the excellent quality of our products and technology is a matter of course.

We are independent, family-run and committed to the values of a medium-sized company in everything we do. That is why our customers may rightly expect not only technologically superior products but also comprehensive, personal commitment to projects all around the world.

Complex special formwork or economical standard formwork: Our experience and wide range of products make us a service partner with strong consulting skills, even for the sophisticated challenges construction professionals have to master nowadays.

AluFix – lightweight hand-set formwork

Efficient building construction

Uncompromising formwork performance

AluFix is the product of choice for crane-free assemblies that have to deliver top-class results. The wide range of panel sizes is ideal for accommodating the various requirements and applications encountered across the globe.

AluFix is a convincing solution for

- residential schemes
- commercial schemes
- civil engineering projects
- municipal and infrastructure schemes
- garden architecture and landscaping projects



i

Simply smart

- **Flexibility**
 - Panel heights 350, 300, 270, 250, 150 and 135 cm and only six panel widths for problem-free corner solutions with any wall thickness
- **Capacity**
 - Permissible fresh concrete pressure (DIN 18218) over full surface of 50 kN/m² (flatness tolerances to DIN 18202, Tab. 3, Line 6)
- **Versatility**
 - Ideally suited for a diversity of functions
 - Great for refurbishment projects
- **Crane-independent**
- **Closed hollow aluminium profile**
 - Ergonomic grip profile
 - Robust frame construction
 - High-grade powder-coated finish
 - Impact- and scratch-resistant surface
 - Easy to clean
- **Smart multi-function profile**
 - Features welded-in Dywidag nuts
 - All accessories, e.g. brackets, push-pull props and alignment rails, attached with MEVA flange screw
- **Intelligent MEVA product design**
 - MEVA assembly lock for structurally continuous connections with only a few hammer blows
 - High-quality alkus all-plastic facing with long-term, 7-year warranty
- **Compatible with EcoAs**



Dry ties

The top ties can be simply replaced by tie claws 23, flange nuts and the D22 plastic tube as a spacer.



Internal tie holes

The 90 and 75 cm wide panels are provided with additional internal tie holes, set back from the edge by around 20 cm, that allow tying without obstruction by waterstops and simplify the shuttering of foundations.



Tie-free

25 to 55 cm wide AluFix panels enable foundations and small walls to be quickly and easily cast without conventional tying components. This is achieved through the use of foundation tape connected to the panels by foundation tensioners. The formwork assembly is dry-tied at the top using the tie claw 23.



AluStar

AluStar makes light work of heavy tasks

Best-in-class for weight-performance ratio

AluStar is MEVA's universal aluminium hand-set formwork range. Light and easy to handle, it is ideal for crane-free use and many other applications.

Stay flexible! As AluStar is 100% compatible with the StarTec steel multi-purpose formwork, it perfectly complements this system as well.

AluStar offers an easily adaptable formwork solution thanks to its wide range of possible combinations. Height increments of 30 cm are achievable through the free connection of formwork panels in the upright or horizontal position.

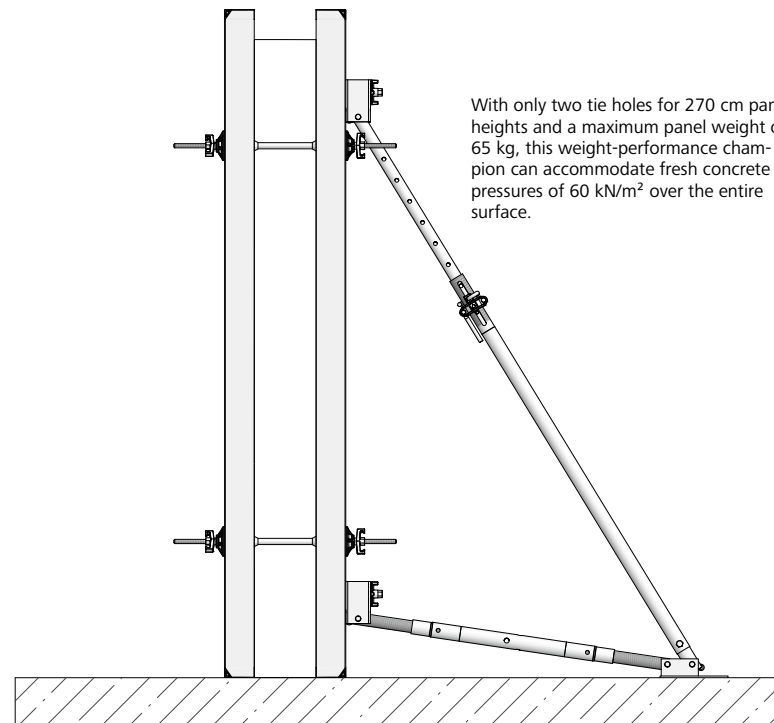

With only two tie holes for 270 cm panel heights and a maximum panel weight of 65 kg, this weight-performance champion can accommodate fresh concrete pressures of 60 kN/m² over the entire surface.

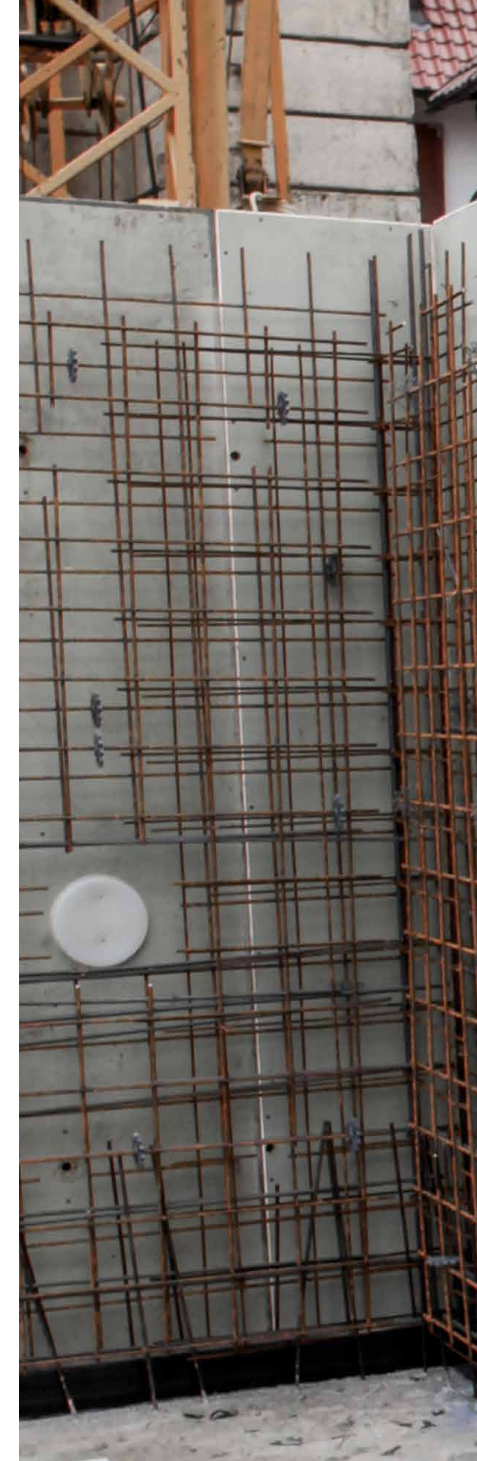



i

Simply smart

Lightweight AluStar at a glance

- **Low weight**
 - Max. 65 kg for largest panel (270 x 90 cm)
- **Capacity**
 - Permissible fresh concrete pressure (to DIN 18218) over entire surface of 60 kN/m² (DIN 18202, Tab. 3, Line 6)
- **Versatility**
 - Ideal for residential and commercial developments
 - Refurbishment projects
- **Closed hollow aluminium profile**
 - Ergonomic grip profile
 - Robust
 - High-grade powder-coated finish
 - Impact- and scratch-resistant surface
 - Easy to clean
- **Smart multifunctional profile**
 - Welded-in Dywidag nuts
 - All accessories, e.g. brackets, push-pull props and alignment rails, attached with MEVA flange screw
- **Tying for inclined or stepped-level formwork**
 - Tie hole with conical aluminium anchor sleeve, welded-in from both sides
- **Intelligent MEVA product design**
 - MEVA assembly lock for structurally continuous connection with only a few hammer blows
 - Cast-iron corners with integral bump notches for panel widths of 55 cm and more to simplify adjustment and alignment with crow bar
 - High-quality alkus all-plastic facing with 7-year warranty
- **Full compatibility with StarTec**

StarTec

StarTec has the answer to many different challenges

Flexible, universal formwork solution

The universal steel formwork that is capable of accommodating fresh concrete pressures of 60 kN/m² is a genuine all-rounder. In terms of top performance and efficiency, StarTec boasts a long and impeccable track record worldwide.

As StarTec is 100% compatible with the compact, lightweight AluStar formwork, it perfectly complements this crane-independent system as well.



SecuritBasic

The safety system with a working platform is easy to install using a single component – the flange screw. A loadbearing capacity of up to 200 kg/m² guarantees start-to-finish safety throughout the assembly and concreting operations.

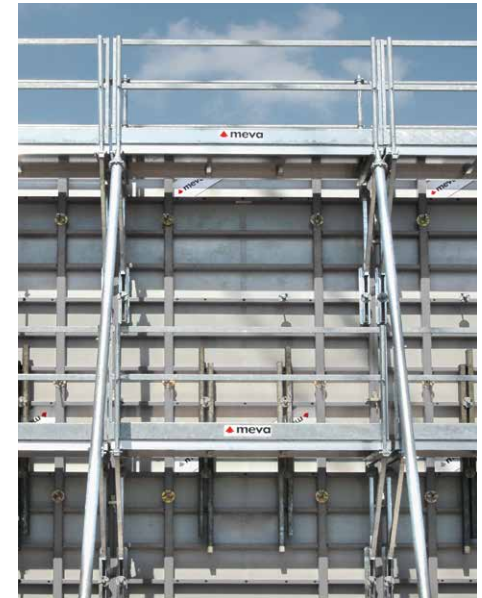

StarTec-Securit

At least as quick to install as a conventional solution with brackets and loose planks, this integrated, pre-assembled safety equipment system offers true value for money. The ready-fitted working platform is delivered to the site in folded form with the StarTec panel. With a low height of less than 30 cm to facilitate transportation, the StarTec-Securit units are ready for immediate use from the stack. The folding platform remains fixed to the panel. The working platform itself is fitted with rear protection, side and front railings as well as an access hatch with integrated ladder and brace frames.



i

Simply smart

StarTec multi-purpose formwork

- **Size**
 - Up to 8.91 m² contact area per panel (330 x 270 cm)
- **Capacity**
 - Permissible fresh concrete pressure (to DIN 18218) over entire surface of 60 kN/m² (DIN 18202, Tab. 3, Line 6)
- **Universal application in residential and commercial developments**
- **Closed hollow steel frame profile**
 - Structurally robust
 - Torsion-proof
 - Hot-dip galvanised to facilitate cleaning and reduce concrete adhesion
- **Smart multifunctional profile**
 - Welded-in Dywidag nuts
 - All accessories, e.g. brackets, push-pull props and alignment rails, attached with MEVA flange screw
- **Tying for inclined or stepped-level formwork**
 - Tie hole with conical steel anchor sleeve, welded in from both sides
- **Intelligent MEVA product design**
 - MEVA assembly lock for a structurally continuous connection with only a few hammer blows
 - Bump notches for panel widths of 135 cm and more to simplify adjustment and alignment with crow bar
 - High-quality alkus all-plastic facing with 7-year warranty
- **Full compatibility with lightweight AluStar**

Single-sided or two-sided tying

Flexibility and cost-effectiveness in the next generation

The StarTec XT with the integrated combination tie hole unites three tying methods in one system. It is possible to switch between these with a flick of the wrist – without installing additional parts. You thus remain flexible and profit from significantly shorter formwork placing times when tying from one side. Another advantage: StarTec XT is fully compatible with StarTec and the lightweight, crane-independent AluStar.



The StarTec XT multi-purpose formwork with its permissible fresh-concrete pressure capacity of 60 kN/m² is the ideal solution for applications in residential and commercial construction.

i

Simply smart

→ Size

- Forming area up to 8.91 m² per panel (330 x 270 cm)
- Panel heights 330, 270 and 135 cm and only 8 panel widths for trouble-free corner solutions for all wall thicknesses

→ Performance

- Permissible fresh-concrete pressure load (as per DIN 18218) of 60 kN/m² (DIN 18202, Table 3, line 6)

→ Universal use in commercial and residential housing construction

→ Closed steel profile

- Structurally robust
- Torsionally rigid
- Hot-dip galvanised for easy cleaning and reduced concrete adhesion

→ Clever multi-function profile

- Multi-function profile made of closed steel profile with welded-in DW 15 nuts for quick and secure attachment of accessories with only one a single part – the flange screw

→ Combination tie hole integrated into the frame with its rotating sphere for three tying methods in one system

- No assembly time for additional parts and accessories
- No loose parts
- Simple handling

→ Initial and final formwork identical

→ Sophisticated MEVA product design

- MEVA assembly lock to produce non-positive connections with just a few hammer blows
- Bump notches for panel widths of 135 cm and greater for simple alignment and adjustment with a crowbar
- High-quality alkus all-plastic facing with 7-year warranty
- Uniform flange screw for all accessories

→ Complete compatibility with StarTec and AluStar



Integrated combination tie hole

Select between three tying methods with a flick of the wrist

Mammut 350

Thinking big with Mammut

Full-surface concrete load capacity up to 100 kN/m²

Through its pioneering development in the 1980s of the large-scale, modular, panelised formwork system known as Mammut, MEVA opened up a whole new dimension in formwork efficiency.

Delivering the optimum combination of cost-effectiveness and flexibility for industrial construction and civil engineering, the Mammut product family regularly sets new benchmarks in the formwork market. The outstanding feature of Mammut 350 is its ability to accommodate fresh concrete pressures of up to 100 kN/m² over the entire surface.

Mammut 350 is easy to set up and allows unlimited pour speeds for heights of up to 4 m. Large formats, with a maximum of 8.75 m² per panel, ensure rapid progress of work on site. Storey heights of up to 350 cm can be cast with a single panel, with no need for vertical extension.



1

Simply smart

Mammut 350 heavy-duty formwork

- **Size**
 - Up to 8.75 m² contact area per panel (350 x 250 cm)
 - For storey heights up to 350 cm without vertical extension
- **Capacity**
 - Permissible fresh concrete pressure (to DIN 18218) over entire surface of 100 kN/m² (DIN 18202, Tab. 3, Line 7)
- **Universal application in industrial construction and civil engineering**
- **Closed hollow steel frame profile**
 - Structurally robust
 - Torsion-proof
 - Hot-dip galvanized to facilitate cleaning and reduce concrete adhesion
- **Smart multifunctional profile**
 - Welded-in Dywidag nuts
 - All accessories, e.g. brackets, push-pull props and alignment rails, attached with MEVA flange screw
- **Tying for inclined or stepped-level formwork**
 - Tie hole with conical steel anchor sleeve, welded in from both sides
- **Intelligent MEVA product design**
 - MEVA assembly lock for a structurally continuous connection with only a few hammer blows
 - Bump notches for panel widths of 125 cm and more to simplify adjustment and alignment with crow bar
 - High-quality alkus all-plastic facing with 7-year warranty
- **Compatible with Mammut XT**
which combines three tying methods in a single system

Mammut XT

Variable tying with minimal effort

Large-area formwork has never been this flexible and easy to use

Mammut is the high-performance, economical solution for modular large-scale construction. With the new Mammut XT system MEVA is setting new standards and thus continuing its success story in the field of 100 kN/m² formwork. As a convincing solution on construction sites Mammut XT maximises cost effectiveness. Mammut XT – the formwork for building construction and civil engineering.



// I am convinced by tangible arguments: 30% less formwork time and significantly fewer components – this offers me clear efficiency advantages//

i

Simply smart

- **Size**
 - Up to 8.75 m² contact area per panel (350 x 250 cm)
 - For storey heights up to 350 cm without vertical extension
- **Capacity**
 - Permissible fresh concrete pressure (to DIN 18218) over entire surface of 100 kN/m² (DIN 18202, Tab. 3, Line 7)
- **Universal application in industrial construction and civil engineering**
- **Closed steel profile**
 - Structurally robust
 - Torsion-proof
 - Hot-dip galvanized to facilitate cleaning and reduce concrete adhesion
- **Smart multifunctional profile**
 - Welded-in Dywidag nuts
 - All accessories, e.g. brackets, push-pull props and alignment rails, attached with MEVA flange screw
- **Combination tie hole integrated into the formwork frame**
 - No assembly time for additional parts and accessories
 - No loose parts
 - Simple handling
- **Initial and final formwork are identical**
- **Intelligent MEVA product design**
 - MEVA assembly lock for a structurally continuous connection with only a few hammer blows
 - Bump notches for panel widths of 125 cm and more to simplify adjustment and alignment with crow bar
 - High-quality alkus all-plastic facing with 7-year warranty
- **Compatible with Mammut 350**



Integrated combination tie hole

Select between three tying methods with a flick of the wrist

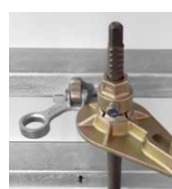

Firmly attachable tie rod holder

Can be attached anywhere in the system



Assembly lock holder

Integrated into the cross stiffeners – for simple logistics on the construction site

MIS – MEVA Integrated Safety

Safety at every construction stage

Efficient and clever

MIS is the foldable all-in-one solution for a fully equipped safety system for MEVA wall formwork. Stairs, rear and side protection, front railings and platform extensions increase the safety at every construction stage, and parking positions for accessories make the work easier. MIS stands for rapid construction progress without having to make economic compromises.





i

Simply smart

→ Safety

- MIS is based on the performance requirements specified in DIN EN 12811 and DIN EN 12812
- Multi-storey use
- Everything in one system: working platform, access ladder, self-closing hatch, rear and side protection, front railing, parking position for all accessories
- Platforms without hindrances: push-pull props outside the railing
- Load capacity up to 150 kg/m² (load class 2)

→ Economic efficiency

- One-off assembly reduces the amount of work involved and speeds up the construction work
- Stackable for space-saving storage, transport and construction site logistics; folded height < 30 cm
- Height can be adjusted in 5 cm increments
- Compatible with MEVA walkway brackets
- Tie rod and assembly lock holders
- Durable due to the use of hot-dip galvanised steel
- Access solution with only two platform widths (250 and 125 cm)
- Platforms remain attached to the panel, simple relocation of the unit using a crane
- Foldable side railings

Radius

The continuously adjustable circular formwork

For radii from 250 cm

The flexible system for curved walls comprises ready-to-use formwork panels accommodating radii upwards of 250 cm. The integrated spindle system allows continuous on-site adjustment of the panels to the required radius. As a special service provided on request, MEVA employees will ensure precise adjustment of the radii or supply you with factory-built radius templates. Radius is compatible with MEVA's AluStar, StarTec, Mammut 350 and Mammut XT wall formwork systems.

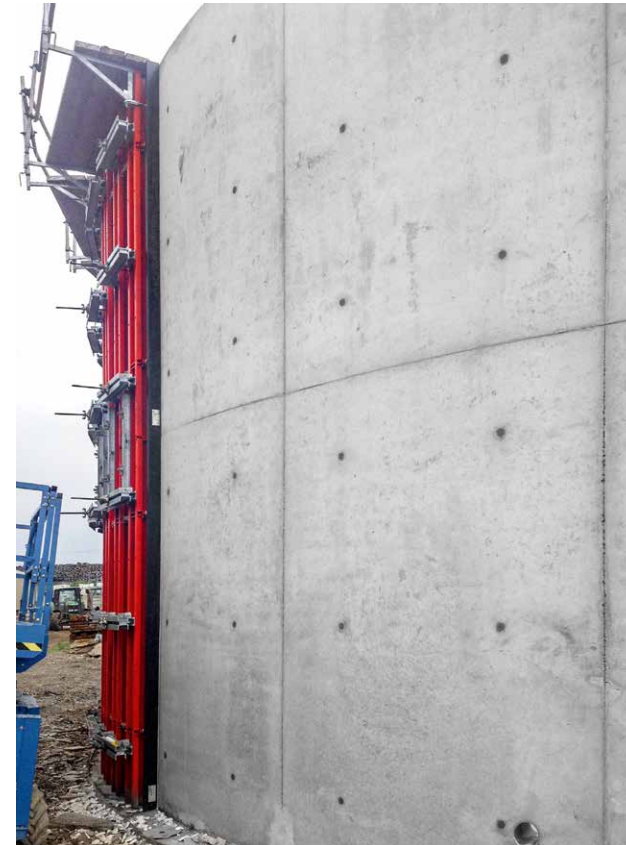



i

Simply smart

- **A top performer**
 - 60 kN/m² fresh concrete load capacity
 - For tall elements, high pour speeds and large formwork cycles
- **Compatibility**
 - AluStar
 - StarTec
 - Mammut 350
 - Mammut XT
- **Panel connection with MEVA assembly lock**
 - Fast, trouble-free junctions with straight walls
 - Uniform working method, streamlined logistics
 - Rapid, labour-saving assembly
- **Easy vertical extension with RS alignment rail and M assembly lock**
- **Intelligent MEVA product design**
 - Millimetre-perfect setting of required radii using integrated spindles
 - Coated steel facing
 - Safe, efficient working through use of MEVA accessories

Circo

Twin semi-circular units for all-round satisfaction

Robust, rigid circular steel column formwork

Circo offers the perfect solution for circular columns, meeting all fair-faced concrete requirements. The steel formwork comprises two identical semi-circular column units. High-grade priming and cavity sealing provide reliable protection against corrosion and facilitate cleaning. Circo formwork can accommodate a maximum fresh concrete pressure of 120 kN/m². It can also be used in conjunction with AluStar, StarTec, Mammut 350 and Mammut XT wall formwork panels to form rounded wall ends.





Simply smart

- **Optimum column height increments**
 - 3 m tall units with 1 m and 0.5 m extensions to cater for all standard heights in 50 cm increments
 - Diameters in 5 cm increments from 25 to 80 cm
 - High-precision fit for stepless vertical extension
- **Safety thanks to**
 - working platform with integrated access hatch
 - ladder
- **Intelligent MEVA product design**
 - Rapid assembly and connection of semi-circular units with MEVA assembly lock
 - Rounded wall ends
 - Straightforward installation of additional MEVA accessories



CaroFalt

Foldable, wheelable column formwork

Quick and reliable for best results

CaroFalt is a byword for the fast, efficient casting of high-quality columns. The system comprises four identical panels that are hinged together in the manner of windmill sails to allow rapid deployment. The assembled unit can be rolled to the next work location using clip-on castors or lifted to the next storey by crane in a single operation.

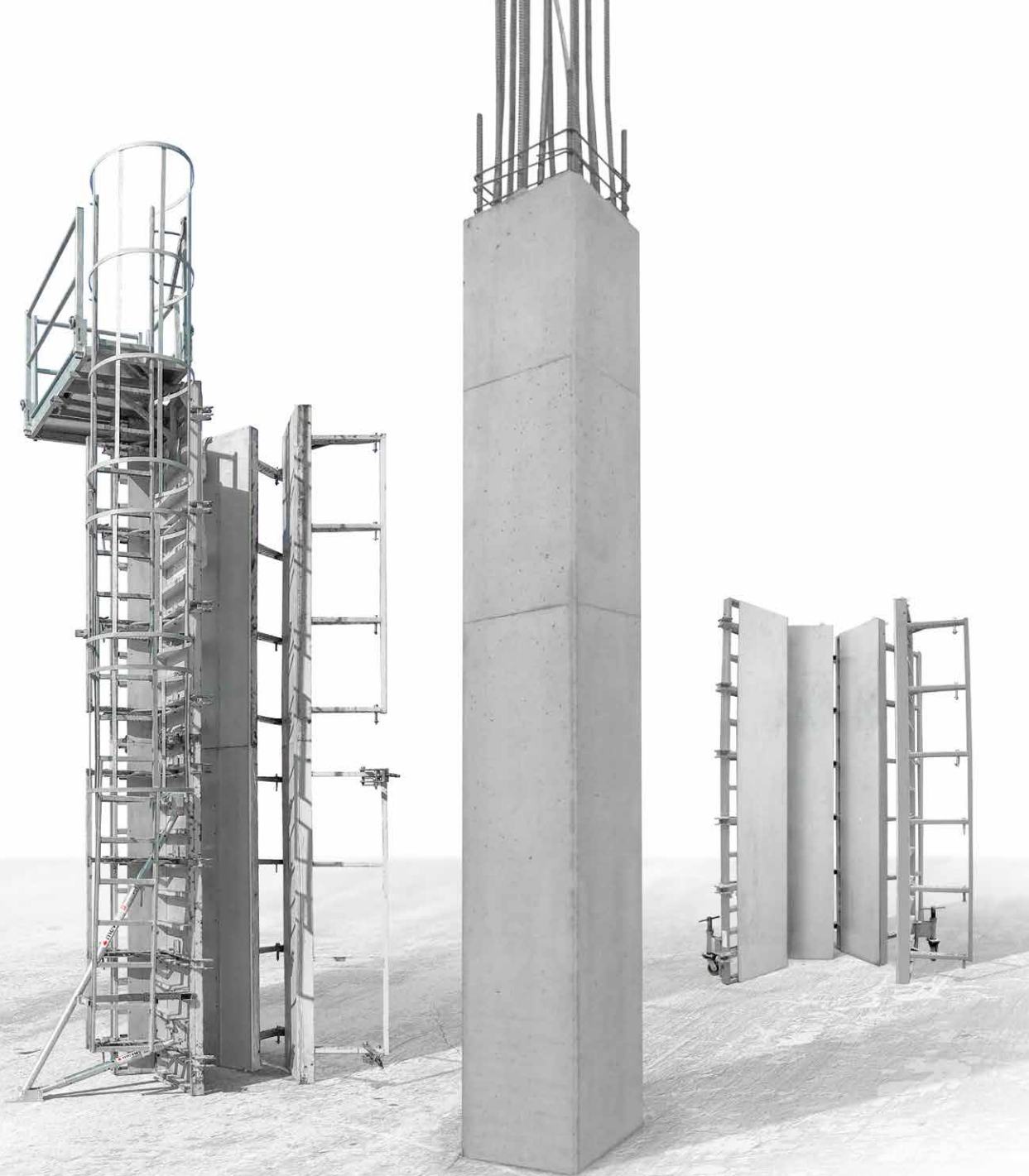



Simply smart

- **Optimum size range**
 - Rapid performance of high pours for 20 to 60 cm column cross-sections
 - Square or rectangular column cross-sections, adjustable in 5 cm increments
- **Built-in safety**
 - Working platform
 - Integral access ladder with rear protection
 - Extensions added at bottom to enhance speed and safety of operations
- **Intelligent MEVA product design**
 - alkus all-plastic facing
 - Standard and bottom extension units connected by AS assembly locks
 - Closed hollow frame profile made of steel: structurally robust, hot-dip galvanised with MEVA finish, making it durable and easy-to-clean
 - Easy-to-use CF spanner for fast opening and closing of formwork, even from ladder
 - Rapid panel connection
 - Meeting highest fair-faced concrete requirements
 - Use of standard MEVA accessories
- **Max. 100 kN/m² fresh concrete load capacity**

MEVA support frames and brace brackets

The clever system for single-sided tying

Ideal for single-sided formwork up against earth walls and the sides of the temporary construction pit.

The support frames and brace brackets are mainly used when working up against existing structures such as walls or rock faces where it is only possible to work from one side. The fresh-concrete pressure is transferred to the support frame via the formwork and then into the foundations.

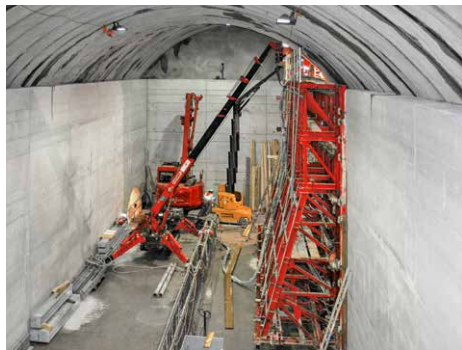

Supporting large loads in restricted spaces.



Supporting single-sided formwork up to a height of 13.50 m.

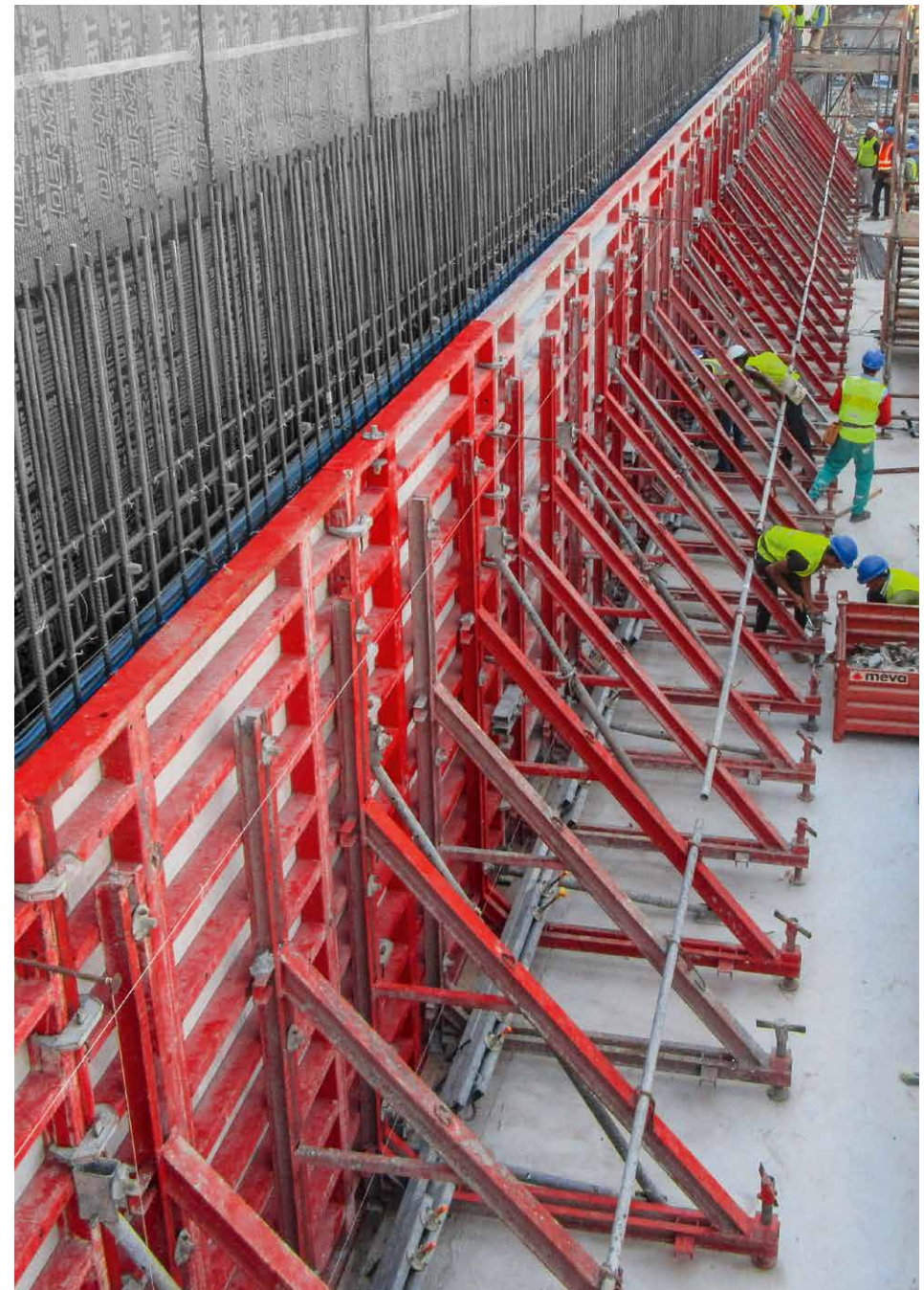

Brace brackets SK 80 and SK 150

The solution for single-sided bracing up to 150 cm with a great many clever product details. Specially designed for floor slabs and slab edge formwork; adjustable with a spindle up to angles of $\pm 15^\circ$.

STB 300 and STB 300 Plus support frames Support frame STB 450

The STB 300 and 300 Plus are stable and economical solutions for single-sided applications with standard or special formwork. Their compact design enables them to be optimally adapted to suit wide-ranging conditions on the construction site.

The STB 450 is ideal when pouring against earth walls and the sides of the temporary construction pit. The use of 1.50 m height extensions enables single-sided walls up to a height of 13.50 m to be formed using the STB 450. The STB 450 is only 2.45 m deep, fits on every truck and can be stored on the construction site in a space-saving manner. It can be easily transported by crane or moved on swivel-type castors.

i

Simply smart

- **Robust steel construction with powder coating**
- **Combinable with all MEVA wall formwork systems, Radius circular formwork or special designs**
- **Can be used horizontally or vertically**
- **Anchoring system with DYWIDAG tie rods for a high level of structural safety**
- **Only 2.45 m deep; fits on every truck and can be stored on the construction site in a space-saving manner**
- **Modular, rapid height extension with STB height extensions**
- **High level of work safety when supplemented by SecuritBasic**

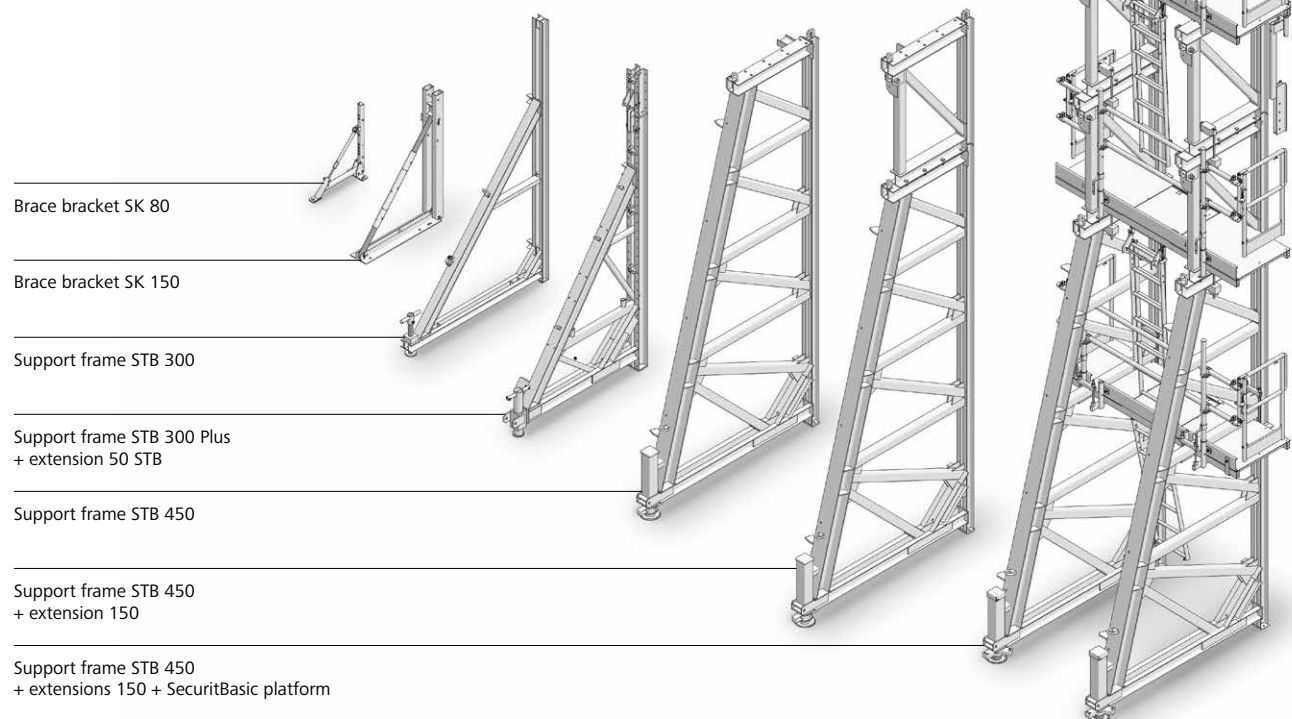

Triplex

The modular heavy-duty prop

For exceedingly stable bracing

Triplex is the heavy-duty bracing system for high wall and column formwork. It can also be used flexibly for additional horizontal and vertical support applications. Triplex consists of individual assemblies that can be combined on the construction site to produce the required length. Basic elements with lengths 50, 100, 200 and 300 cm are supplemented by foot plates and top units with a spindle which can be precisely adjusted using the left- or right-hand thread.

Triplex is available in two versions:

- **Triplex R**
for use as a push-pull prop. In this application the prop is simply connected by means of a formwork-prop connector for wall and column formwork up to 16.00 m.
- **Triplex SB**
for efficient bracing of the STB support frame up to 13.50 m.

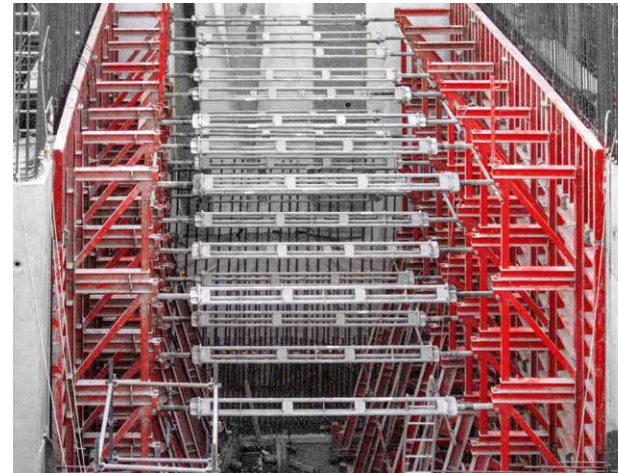



i

Simply smart

- To support and align high wall and column formwork
- Stable and robust for safety at great heights and for efficient bracing of the STB support frame
- Flexibly combinable
- Economical and quick
- Besides being used for bracing, their are also various other possible horizontal and vertical applications



Triplex as support for platforms, overhanging slabs and cantilevered balconies.

MevaDec

The efficient and ergonomic slab formwork

The new generation

Lighter and more ergonomic: The new MevaDec generation convinces due to the low weight and ease of cleaning of all its components as well as its optimised handling properties – based on all the tried-and-tested MevaDec system advantages.

MevaDec is not bound to a rigid grid pattern, meaning that it can be flexibly adapted to suit any building layout and any slab thickness. Minimized filler areas allow it to be set up more quickly. In the process, the predefined prop spacing ensures safety and optimised material stock on the construction site.





Simply smart

- **Size and weight**
 - Largest panel 160/160 cm
 - Weight-optimised system for ergonomic and thus efficient work
 - Standard panel 160/80 cm weighs only 16 kg/m² – almost all requirements can be covered with only one panel size
- **Safety due to prop spacing defined by the system**
- **One system – three slab-forming methods**
 - Drop-head-beam-panel method
 - Primary- and secondary-beam method
 - Panel method
- **Closed aluminium section**
 - Ergonomic grip profile
 - High-quality cured powder-coated finish for easy cleaning and reduced concrete adhesion
- **Sophisticated MEVA product design**
 - High-quality alkus all-plastic facing AL 10 with 7-year long-term warranty
 - Durable and easy to repair
- **Compatible with previous generation**



Robust, lightweight panels with grip openings to simplify handling.



Fewer compensations saves time. Even uneven slab edges can be solved with a minimum of filler areas.

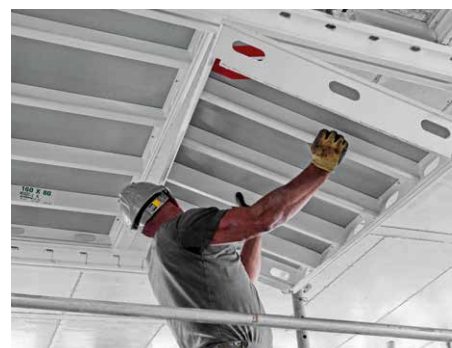

The ergonomic grip profiles facilitate installation, also from below.

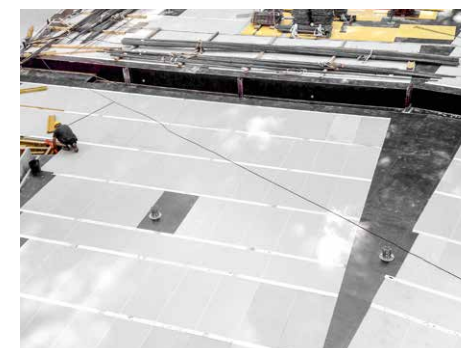

Fewer job-built solutions saves money. Trouble-free connections to conventionally formed areas.



MevaFlex

The conventional slab formwork

Economical and tried-and-tested

MevaFlex: conventional slab formwork with facings, crossbeams and girder stringers on props or shoring towers. Freely selectable facing: shuttering panel 3S, alkus all-plastic facing or other alternatives.

Flexible and cost-efficient

The positioning of the beams and props is not predefined and can thus be optimised in accordance with the slab thicknesses during the planning phase. This results in flexible fields of applications for varying building layouts as well as slab thicknesses.

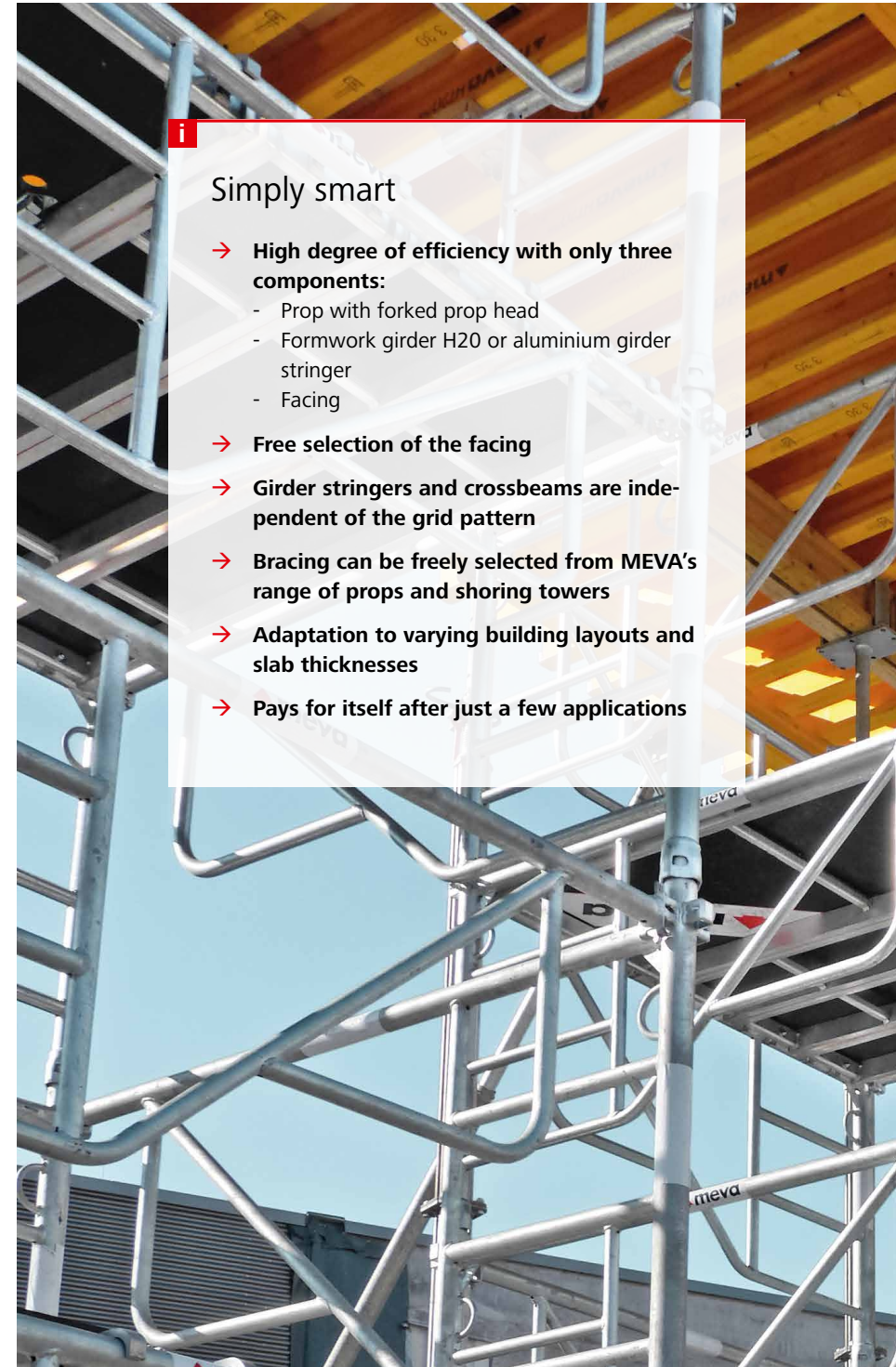

Simply smart

- **High degree of efficiency with only three components:**
 - Prop with forked prop head
 - Formwork girder H20 or aluminium girder stringer
 - Facing
- **Free selection of the facing**
- **Girder stringers and crossbeams are independent of the grid pattern**
- **Bracing can be freely selected from MEVA's range of props and shoring towers**
- **Adaptation to varying building layouts and slab thicknesses**
- **Pays for itself after just a few applications**



Flexible even for large surface areas



MevaFlex is the ideal solution to support prefabricated slabs



Flexibly adaptable to suit every building geometry

VarioMax

Only three component types

Simple, cost-effective and sustainable

VarioMax is a flexible, lightweight support system, assembled from only a few parts, that is used for the construction of precast and in-situ concrete slabs. It comprises only three basic component types: prop, double beam and slide-in beam. VarioMax needs up to 50% fewer props and components than for standard methods and reduces the labour requirement accordingly. The system excels by its low weight, straightforward handling and flexible adaptation to any layout.

VarioMax is fully compatible with MEVA props and shoring tower systems. The aluminium double and slide-in beams with their grid-free telescopic function are lightweight, durable and designed for heavy duty, making them more sustainable than H20 beams. Their powder-coated finish reduces concrete adhesion, which in turn allows prompt, resource-efficient cleaning.

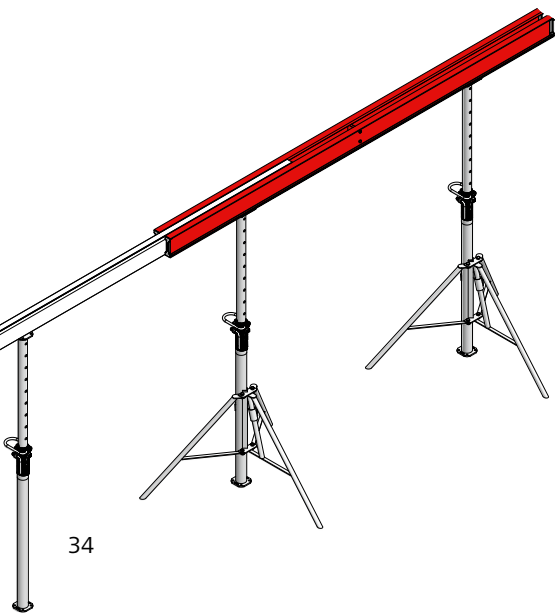



i

Simply smart

- **Flexible, lightweight support system for precast floor slabs**
 - Low weight
 - High load capacity
- **Integral connection pin in beams**
 - Prop positions predefined by prop grid, thereby facilitating assembly
 - Unnecessary extra props can be eliminated
 - Reduced time and material requirement cuts costs while simplifying storage and logistics
- **Full compatibility with MEVA props and shoring tower systems**
- **Telescopic double and slide-in beams made from powder-coated aluminium**
 - Long service life and more sustainable than H20 beams
 - Lower concrete adhesion, easy to clean
- **Only three component types and few parts**
 - Prop, double beam and slide-in beam
 - Grid-free adaptation to all layouts



The integral connection pin dictates prop positions, simplifies assembly and prevents props from falling over.



Readily adaptable, heavy-duty and lightweight telescopic main and slide-in beams.



Straightforward, non-strenuous handling thanks to low weight.

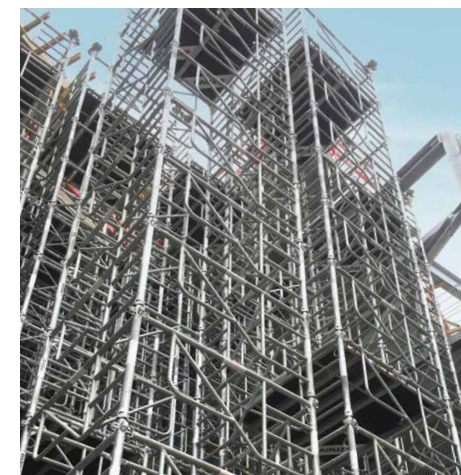

Full compatibility with MEVA props and MEP/MT 60 shoring tower systems.

MEVA FormSet

System-independent accessories

Easier working, lower labour costs

As fall protection systems are only ever as good as their supporting construction, a sound base connection is essential. In conjunction with the MEVA guarding-rail posts and safety mesh, the shoe universal MFS ensures dependable all-round fall protection. A secure construction is achieved through use of the tried and tested spiral anchor DW 15/100 or the quick anchor DW 15, attached with a flange screw 12.

EuMax is the high-performance, all-round, all-purpose prop range. Provided with a high-grade galvanised finish, the props offer a combination of high flexibility and type-tested safety, with production certified to DIN ISO 9001. The permissible load capacity is 20 kN for Class D props at all extensions and 30 kN for Class E props.

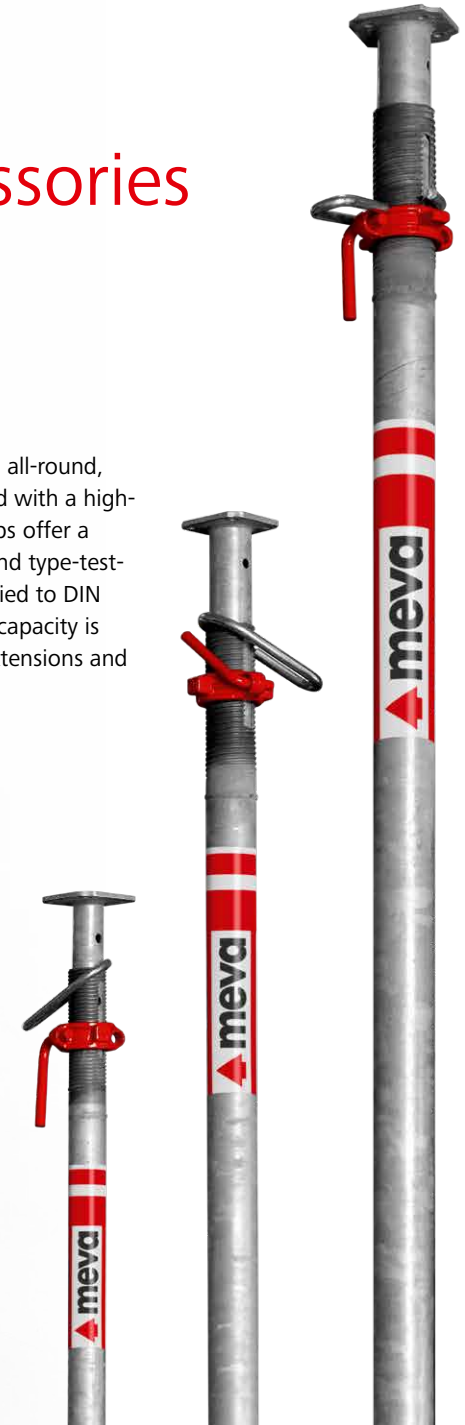



Simply smart

- Stable construction and captive components
- Fast and easy to install with a long service life
- Saves time, money and materials
- Convenient accessories
- Easy handling
- Absolute reliability

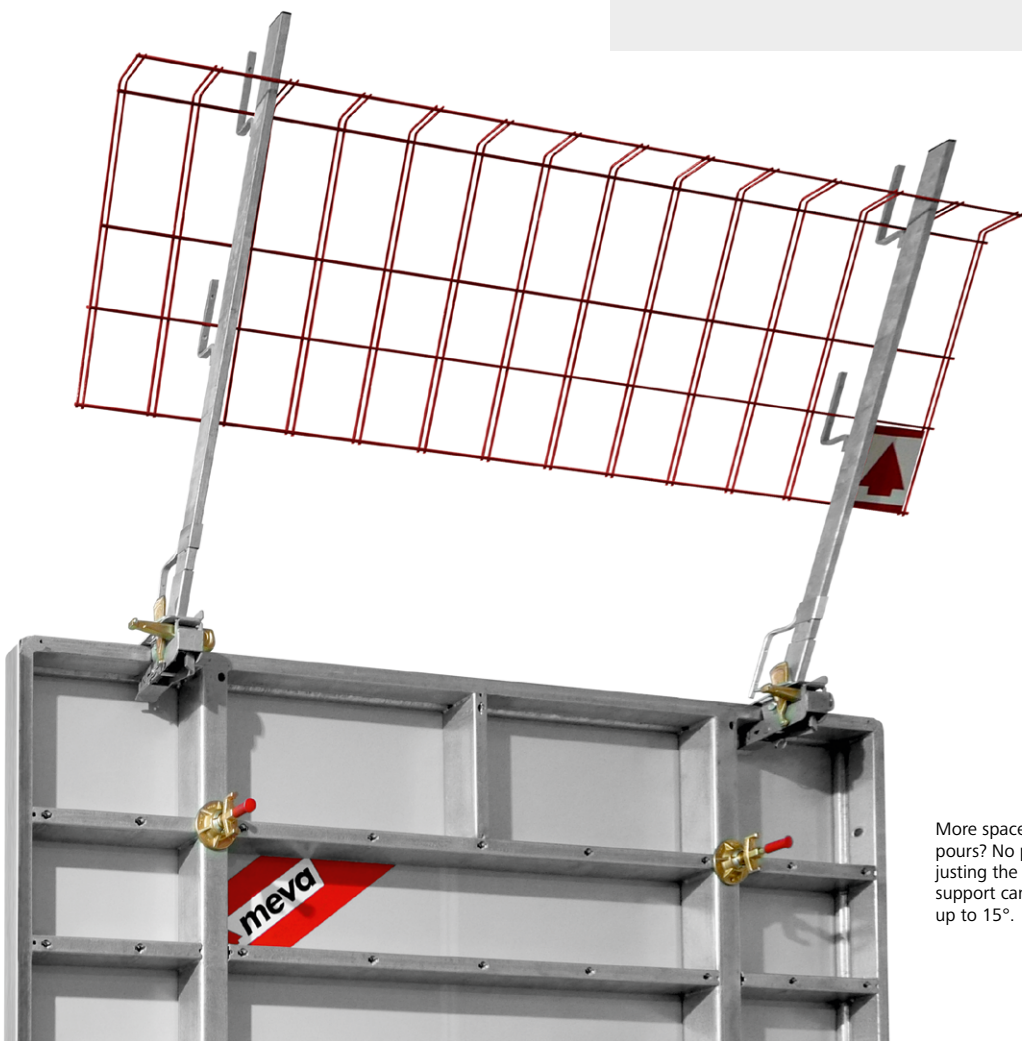

More space needed for pours? No problem: by adjusting the wedge, the tilting support can be inclined by up to 15°.

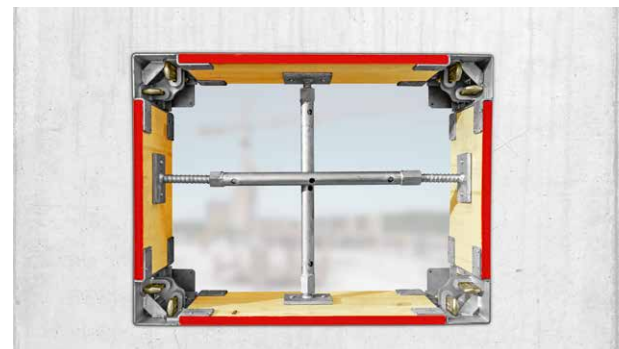

In next to no time, four box out corners can be fitted as a box out set. Different plywood lengths allow flexible use. The attachment of chamfer strips to the formwork is recommended for the best possible results.



The quick anchor DW 15 is suitable for both ground and suspended slabs. It is ideal for installing safe anchorings with the flange screw 18 or tie rod DW 15 for braces, shoes for safety mesh, single-sided propping and a wide range of other uses.



Nailable connector
Made from red plastic, the nailable connector for fair-faced concrete DW 15 is used to attach anchor sleeves DW 15 to the facing.

Fair-faced concrete plug
The fair-faced concrete plug DW 15 is used to seal the nailable connector for fair-faced concrete. It is glued in with concrete glue A + B.

MT 60 shoring tower system

Built-in speed and safety

Only few standard parts for large tower heights.

With only three frame heights (100, 75 and 50 cm), together with foot and head spindles that are vertically adjustable up to 44 cm and 62 cm respectively, the system can be used for all tower heights up to 18.66 m (in line with type test).

MT 60 is easy to assemble, with no tools needed, and can be relocated as a complete tower unit by crane or on castors. Given that all components are hot-dip galvanised, it not only guarantees maximum safety at any height, but also enjoys a long service life, with a low maintenance and cleaning requirement.

Compatible with all MEVA slab systems

Compatible with MEP shoring tower

Built-in safety throughout assembly, operation and dismantling



Crane eyes integrated in every frame

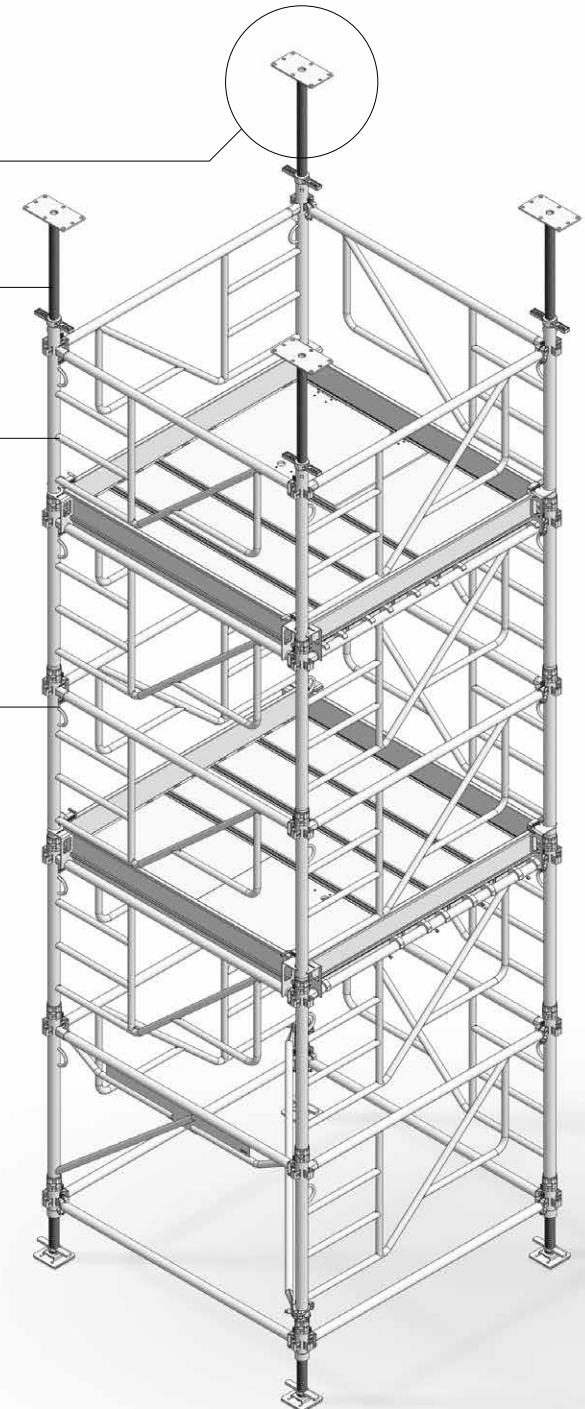



Simply smart

- **A top performer**
 - 60 kN load capacity per leg, for high loads and slab thicknesses up to 71 cm
- **Built-in safety solutions**
 - Safety access ladder in each tower segment
 - Fall protection on all sides of working platform
 - Access hatch
 - Self-locking connections even during assembly
 - Tower planking automatically secured in frame
- **Intelligent MEVA product design**
 - Straightforward vertical or horizontal assembly on ground – without tools, bolts or pins
 - Easy to move as complete tower unit by crane or on castors – crane eyes integrated in every frame
 - Only three frame types for all heights up to 18.66 m: 100, 75 and 50 cm
 - Max. weight approx. 15 kg per individual component

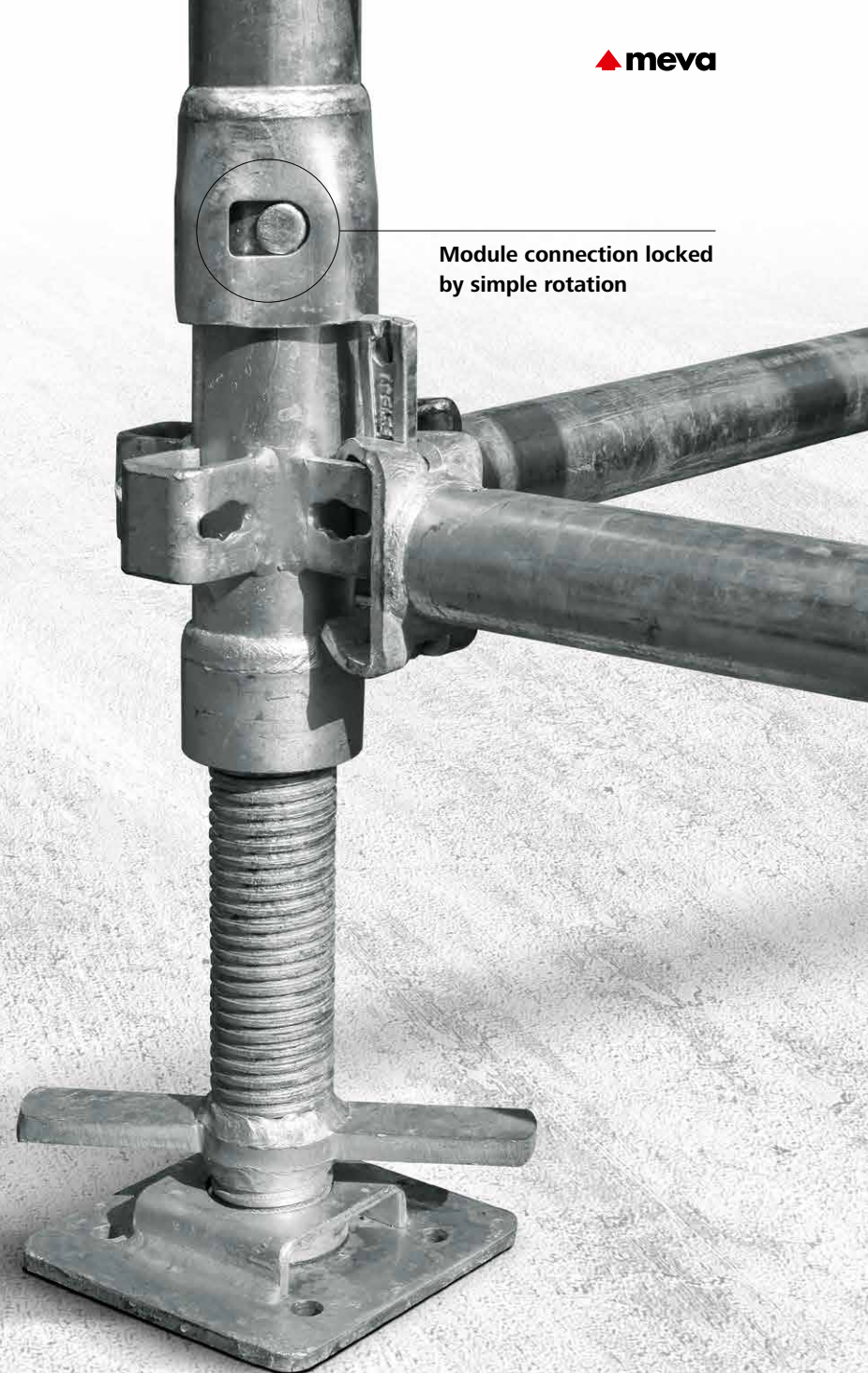

Module connection locked by simple rotation

MEP shoring tower system

Maximum flexibility

MEVA quality in every detail

For all applications at height. Thanks to its modular design, the MEP system is flexibly adaptable to any building geometry without creating a "forest of props". Only few basic components – props, extensions and frames – are needed to build a stable shoring tower. Allowing flexible vertical adjustment, the system offers the ideal means of supporting slab formwork, slab tables, beams and precast units for heights up to 21 m.

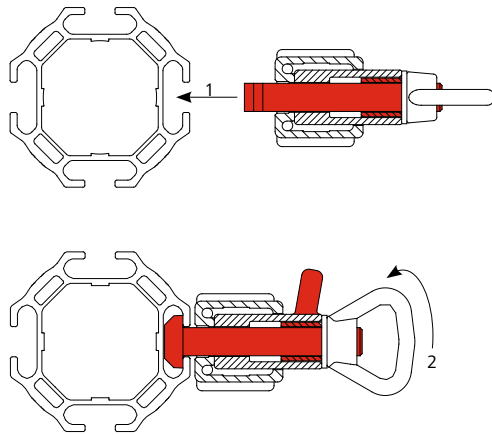

MEP rapid frame connector

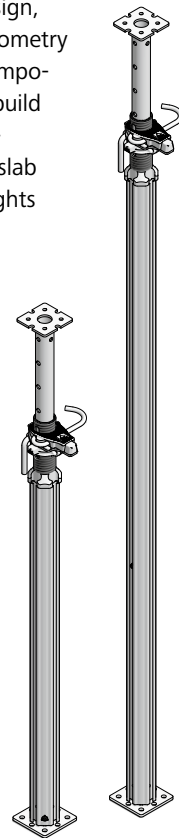

MEP props with SAS

Compatible with all MEVA slab systems and MT 60 shoring tower

Few basic components

MEP rapid frame connector for enhanced safety

SAS quick-lowering system

Inner tube extension

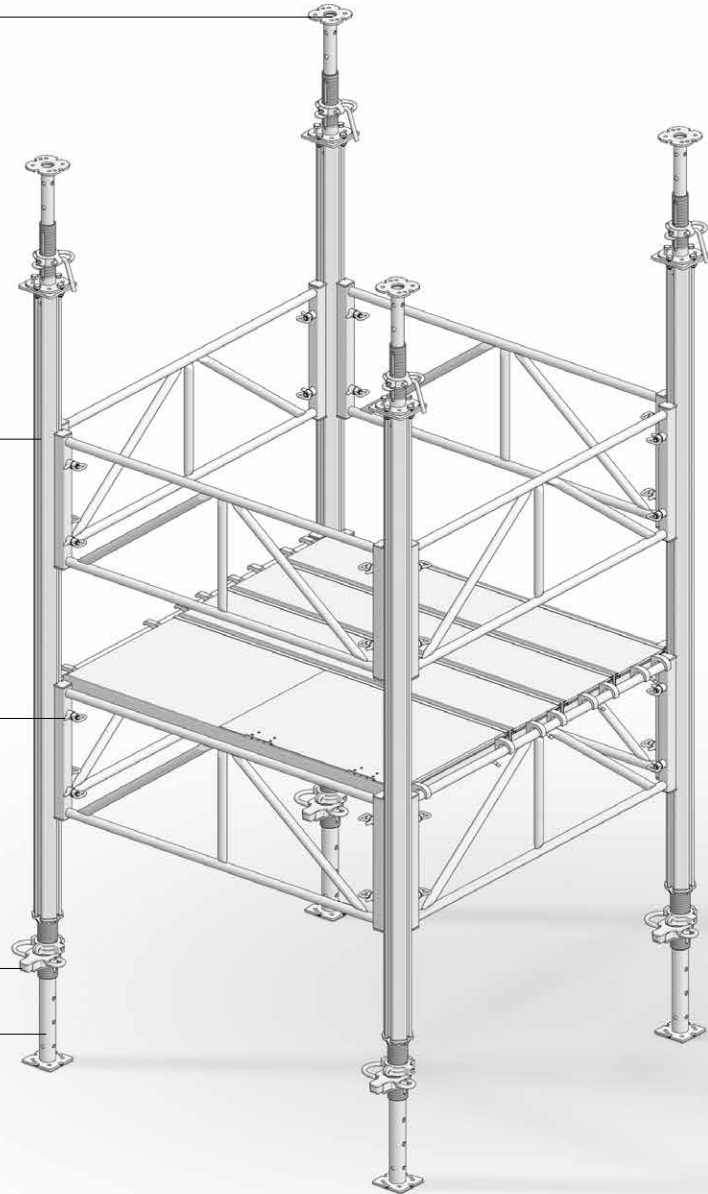

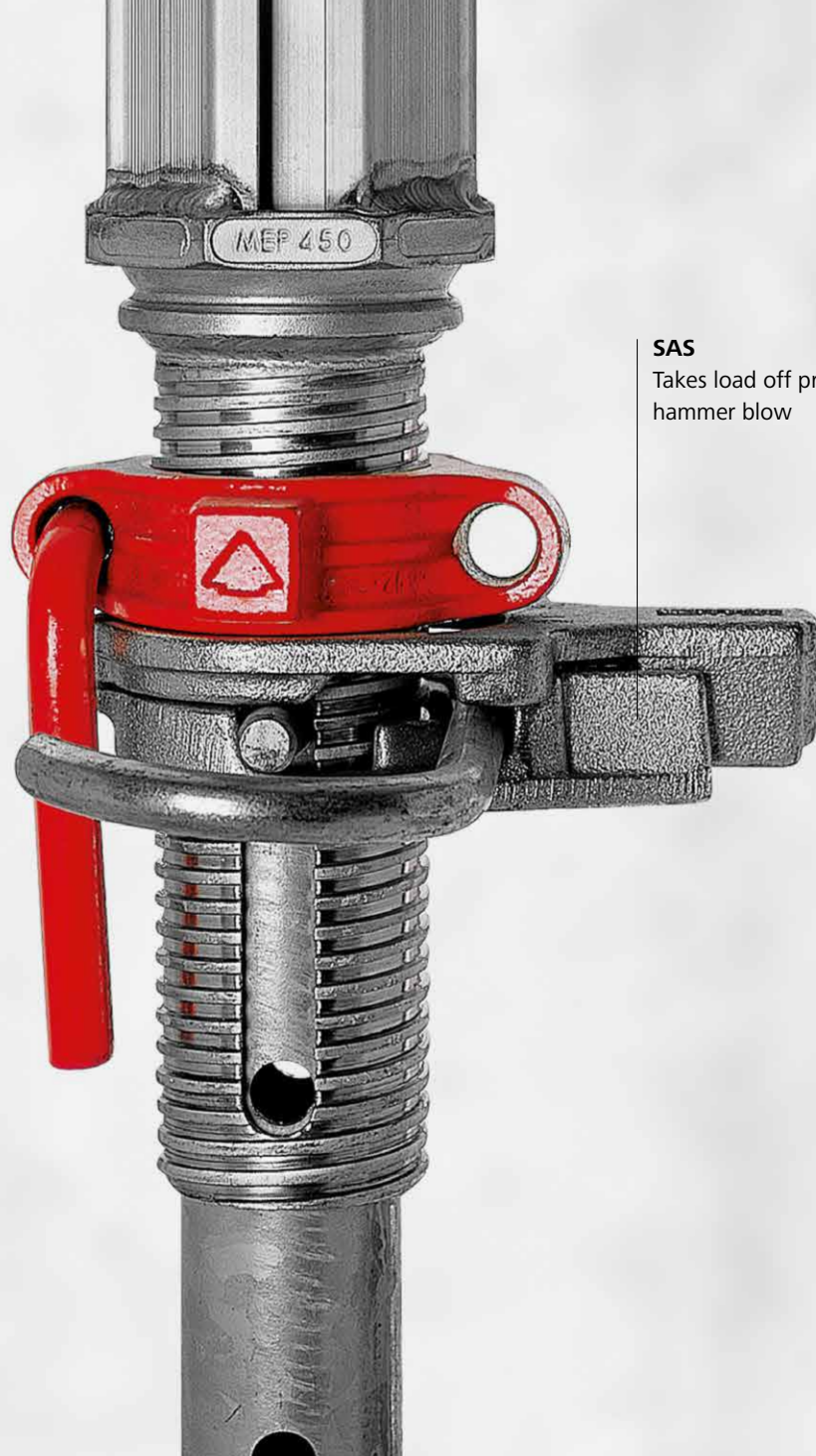

SAS

Takes load off prop by hammer blow



Simply smart

→ A top performer

- Versatile system for supporting slab formwork, slab tables, beams and precast units for heights up to 21 m

→ Intelligent MEVA product design

- Few basic components: props, extensions, frames, thereby streamlining storage and logistics
- Inner tube extension adjustable for each individual MEP prop
- MEP rapid frame connector makes safe connections visible at a glance
- Reinforcing frame fitted to MEP prop with rapid connector
- Adjustable cross-braces for all prop spacings from 90 to 300 cm
- MEP tube coupler for fixing at any position on profile
- Calotte support to offset sloping surfaces
- All platforms automatically secured in frames against disengagement
- Lift truck for movement of complete shoring units

→ MEVA lowering system

- The SAS quick-lowering system takes the load off the prop with a single hammer blow.

SecuritBasic – the safety system

Safety for every wall formwork

Everything in one system: platforms, access ladders, safety cages, front railings, brace frames and side railings

SecuritBasic is the MEVA safety system with working platforms for cost-effective work at all heights. It prevents accidents through coordinated safety and increases the work efficiency. SecuritBasic is compatible with StarTec, StarTec XT, Mammut 350, Mammut XT and the STB 450 support frame. The individual parts can be used in all systems. This reduces the complexity and material stock on the construction site.

Four platforms enable it to be adapted flexibly to suit the formwork structure. A platform width of 75 cm allows work to be performed comfortably and safely.



The units consisting of formwork and working platforms can be moved effortlessly in one piece. Tie rods and accessories can be used safely at all heights.



Like all other MEVA accessories, SecuritBasic is attached to the welded-in DW nut in the multi-function profile using the flange screw. Additional attachments and parts are not required. This eases the assembly.



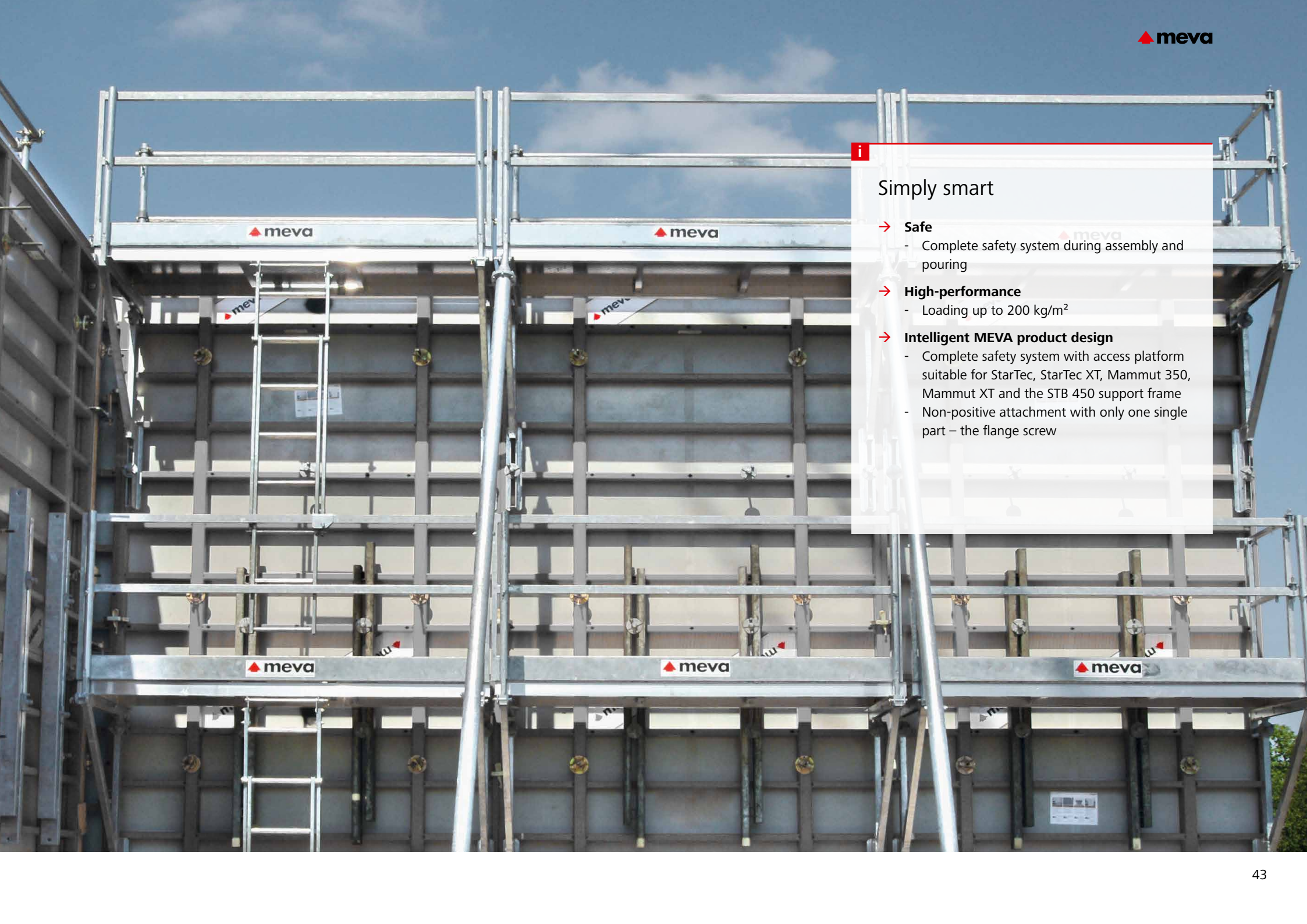

i

Simply smart

- **Safe**
 - Complete safety system during assembly and pouring
- **High-performance**
 - Loading up to 200 kg/m²
- **Intelligent MEVA product design**
 - Complete safety system with access platform suitable for StarTec, StarTec XT, Mammut 350, Mammut XT and the STB 450 support frame
 - Non-positive attachment with only one single part – the flange screw

BKB – the foldable pouring platform

Guaranteed safety in every situation

Just hook into place

MEVA's BKB foldable pouring platform can be rapidly mounted on formwork panels to provide a safe working scaffold. Just fold out, hook into place and start work. Self-locking suspensions are available for MEVA's AluStar, StarTec, Mammut 350 and Mammut XT formwork systems.

The side railing 125 can be flexibly used to fill gaps, provide rear protection or close off ends. Various platform lengths allow adaptation of the system in line with requirements.



Safe, easy and fast. The BKB foldable pouring platform is simply hooked into place on the formwork panel.

The low stacking height helps to economise on space during storage and transportation.



i

Simply smart

- **Safe**
 - Self-locking suspension mechanism
 - Safety thanks to side railing and corner platform
- **No time lost – just fold out, hook into place and start work**
- **A top performer**
 - Load capacity of 2 kN/m² in line with DIN 4420
- **Intelligent MEVA product design**
 - Preassembled, foldable guard railing
 - Generous platform width of 125 cm
 - Low stacking height of 17 cm
 - Platform lengths of 140, 235 and 300 cm

KAB – the foldable working platform

A versatile solution

Meeting diverse building construction needs

MEVA's KAB foldable working platform is ready to use from the stack, with no tools or loose parts needed for on-site assembly. When lifted by crane, the platform folds out and automatically locks into the open position.

Whether used as a safety scaffold with masonry and at roof edges or as a climbing scaffold in conjunction with formwork, the KAB platform provides a robust and cost-effective solution requiring only few ancillary components and adaptable to virtually any situation encountered in building construction.

KAB with trailing platform for follow-up works.





Simply smart

- **Safe and flexible**
 - For use as safety scaffold
 - For use as working scaffold
 - For use as climbing scaffold with formwork
 - For use as safety and fall-arrest scaffold below eaves (with height adjustment 100)

- **A top performer**
 - Cone or loop suspension for working loads up to 3.0 kN/m²
 - Platform supporting wall formwork heights up to 4.25 m, braced with push-pull props

- **Intelligent MEVA product design**
 - Preassembled for rapid deployment
 - Generous platform width of 190 cm – ample space for formwork and scaffolds
 - 225 and 350 cm platform lengths
 - Corner platforms for various geometries
 - Only 25 cm high when folded, allowing efficient storage and logistics

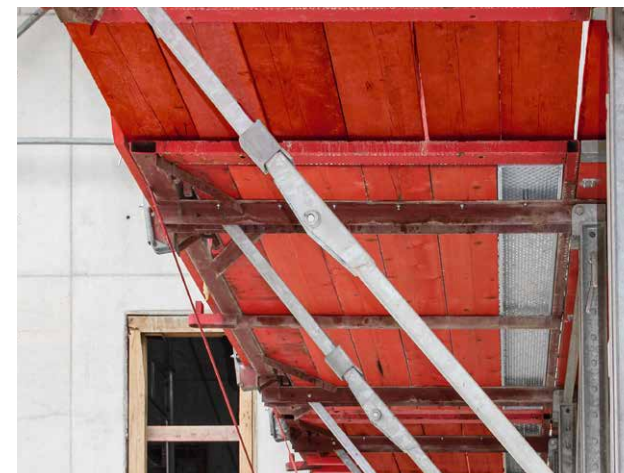

Braces fitted with automatic gravity locks.

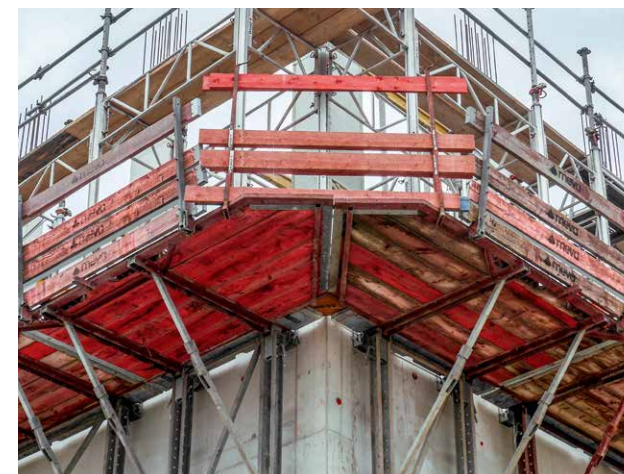

The 190 cm wide platform offers ample space, even after formwork or scaffold frame assembly. The corner platforms can accommodate acute, obtuse and right-angled corners.

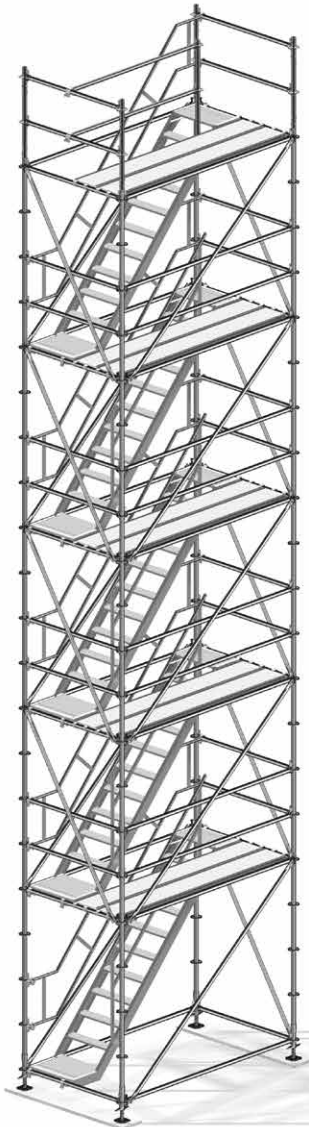

MTT Stair Tower

Access up to 115 m and higher

Safe, simple, comfortable

In addition to the completely integrated access systems with safety cages and fixed ladders for wall, rectangular column and circular column formwork systems, MEVA offers the stair tower as a comfortable access system.

The MEVA MTT Stair Tower is the all-in-one-solution for stationary ascent and descent in every situation. It convinces due to its flexibility and simple assembly. The stair tower can be height-extended both on the ground and when upright. The structural analysis covers heights up to 115 m.





i

Simply smart

- **Can be used as**
 - Stair tower for vertical access
 - Scaffolding for rebar work
- **Modular design principle**
 - Few system parts
 - Simple assembly
 - Can be flexibly adapted and extended
- **The structural analysis covers heights up to 115 m; additional height extensions are possible with a separate verification**
- **Non-slip steel floors, load-bearing capacity up to 200 kg/m²**
- **Identical step height throughout**
- **Egress possible on both the short and the long side**
- **Robust construction with flexible assembly**



All MTT posts have punched discs every 50 cm for up to eight connections. Four small recesses in the punched disc are for rectangular connections and the four larger recesses are for connections at any angle.

Space Shoring Tower

Efficient at great heights

Safe access and work

The Space Shoring Tower provides the necessary support for the formwork with just a few system parts and at the same time serves as a working scaffold for rebar and concrete work, even above a height of 35 m.

When particularly high, vertical components such as rectangular or round columns are formed, MEVA's Space Shoring Tower provides a safe and economical alternative to conventional bracing systems. The individual tower segments with a quadratic cross-section of 4.80 m x 4.80 m are pre-assembled on the ground and then bolted together. The construction consists of 300 cm high segments and 50 and 100 cm extensions.

When assembled, the Space Shoring Tower can be moved safely and quickly by crane. The working levels are equipped with commercially available planking. This enables the access hatches to be positioned as required.

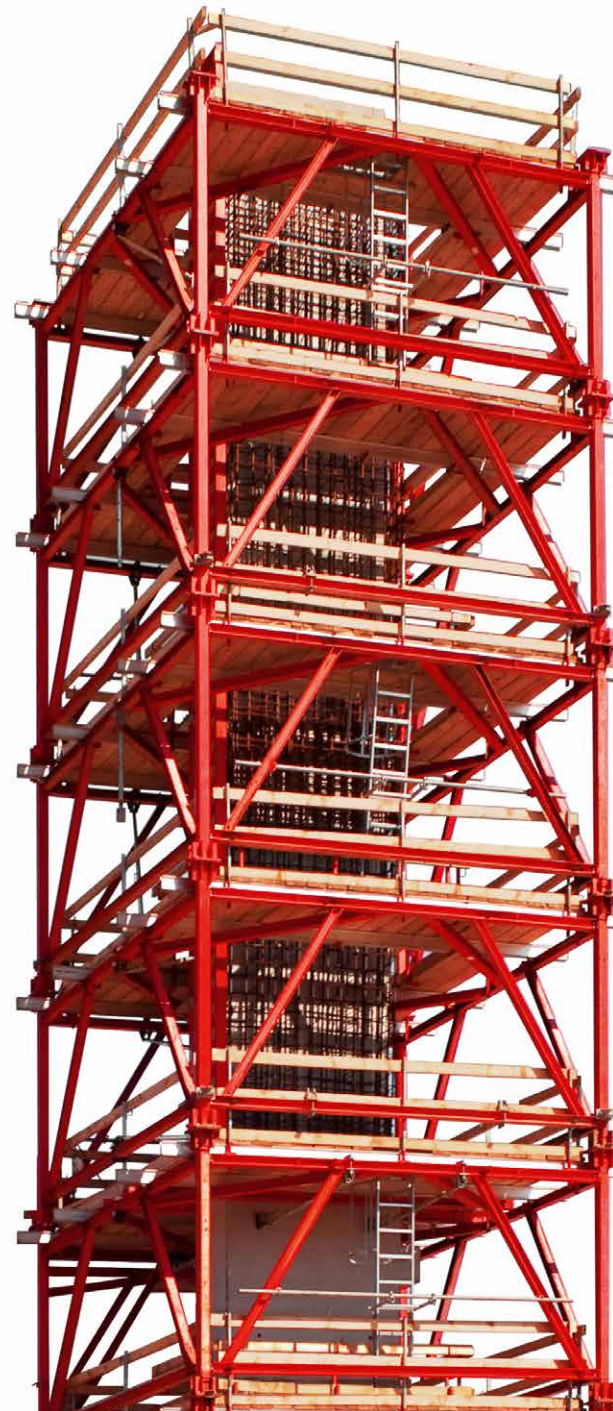



i

Simply smart

- **Shoring tower with square cross-section for vertical components (columns and large panels)**
 - Few system parts
 - Support for the formwork
 - Working scaffold for rebar and concrete work
 - 4.80 m x 4.80 m cross-section with access hatches
- **Robust steel construction with powder coating**
- **Flexible assembly**
- **Preassembly on the ground, height-extendible**
- **3.00 m high segments as well as 0.50 and 1.00 m extensions available**
- **Wind loads can be transferred to the shoring tower**
- **Can be adapted to the formwork of each cycle**
- **Perfectly complements circular and rectangular MEVA column formwork**
- **Low transport volume: with a height of 2.46 m, it fits on any truck**



Pre-assembled segments can be lifted for rapid height extension.

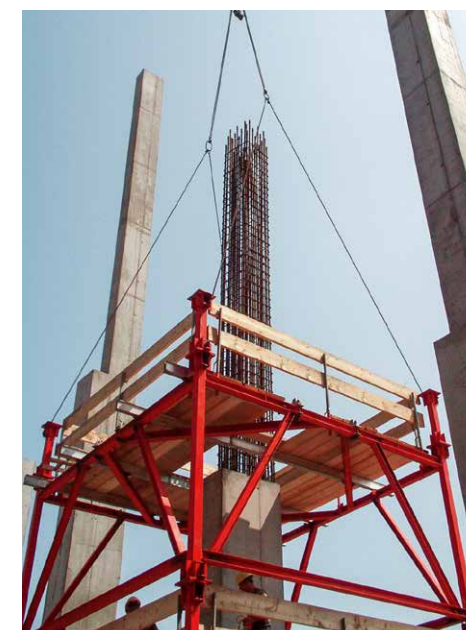

KLK 230 climbing system

Safe and flexible

The multifunctional climbing system

The KLK 230 climbing system with a 2.30 m wide platform provides all the technical advantages of large-area formwork irrespective of the height of the building – with the same level of safety as at ground level.

The KLK 230 can be used as climbing formwork and as a working platform for rebar, formwork set-up and concrete-pouring work. It can be easily supplemented with a trailing platform in order to perform follow-up work.

The KLK 230 climbing system is firmly attached to the wall formwork to form a craneable climbing unit. The formwork clamping fixture allows both the height (up to 23 cm) and the inclination of the formwork to be finely adjusted in order to precisely adapt it to the geometry of the building.

The formwork can be moved back by 70 cm using a slide carriage, creating sufficient space to perform cleaning and boxout work comfortably.



The KLK 230 climbing system consists of climbing brackets, wall struts, planking and handrails.



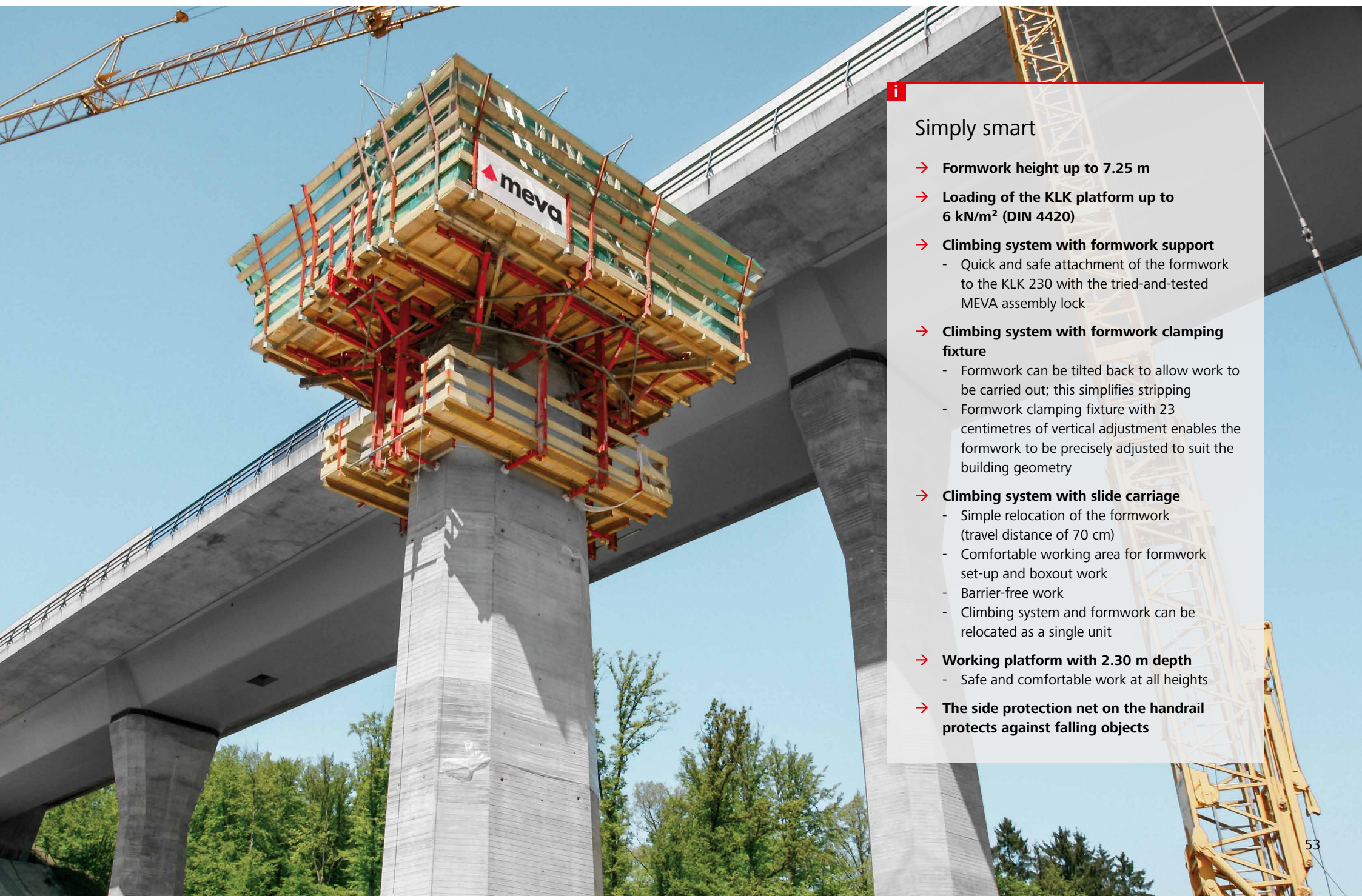

i

Simply smart

- **Formwork height up to 7.25 m**
- **Loading of the KLK platform up to 6 kN/m² (DIN 4420)**
- **Climbing system with formwork support**
 - Quick and safe attachment of the formwork to the KLK 230 with the tried-and-tested MEVA assembly lock
- **Climbing system with formwork clamping fixture**
 - Formwork can be tilted back to allow work to be carried out; this simplifies stripping
 - Formwork clamping fixture with 23 centimetres of vertical adjustment enables the formwork to be precisely adjusted to suit the building geometry
- **Climbing system with slide carriage**
 - Simple relocation of the formwork (travel distance of 70 cm)
 - Comfortable working area for formwork set-up and boxout work
 - Barrier-free work
 - Climbing system and formwork can be relocated as a single unit
- **Working platform with 2.30 m depth**
 - Safe and comfortable work at all heights
- **The side protection net on the handrail protects against falling objects**

The rail-guided MGC-H climbing system

Safe work at all heights

Rail-guided lifting using hydraulics or by crane

The rail-guided MGC-H climbing system (MEVA Guided Climbing) climbs as a unit and consists of wall formwork and working platforms. Hydraulically or by crane.

Safe and efficient assembly on the ground

Thanks to the MGC-H's clever design, the units – including guide rail and ladder extensions, trailing platforms and other components – can be assembled safely and in a time-saving manner under simple assembly conditions on the ground.

Extensions and trailing platforms installed from below

When the climbing unit has been installed on the building, the extensions, trailing platforms and access ladders are also installed from below. This increases the safety of the system and the efficiency during assembly.

MGC-H and wall formwork – always a safe unit

The MGC-H and the wall formwork always form a single unit. The use of guide rails ensures that it remains firmly anchored to the building even under windy conditions – during both the construction phase and the climbing phase (hydraulically or by crane). It is possible to work ergonomically at all times thanks to cleverly designed components such as weight-optimised hydraulic cylinders, the mobile hydraulic unit as well as the lightweight MGC-H guide shoe.

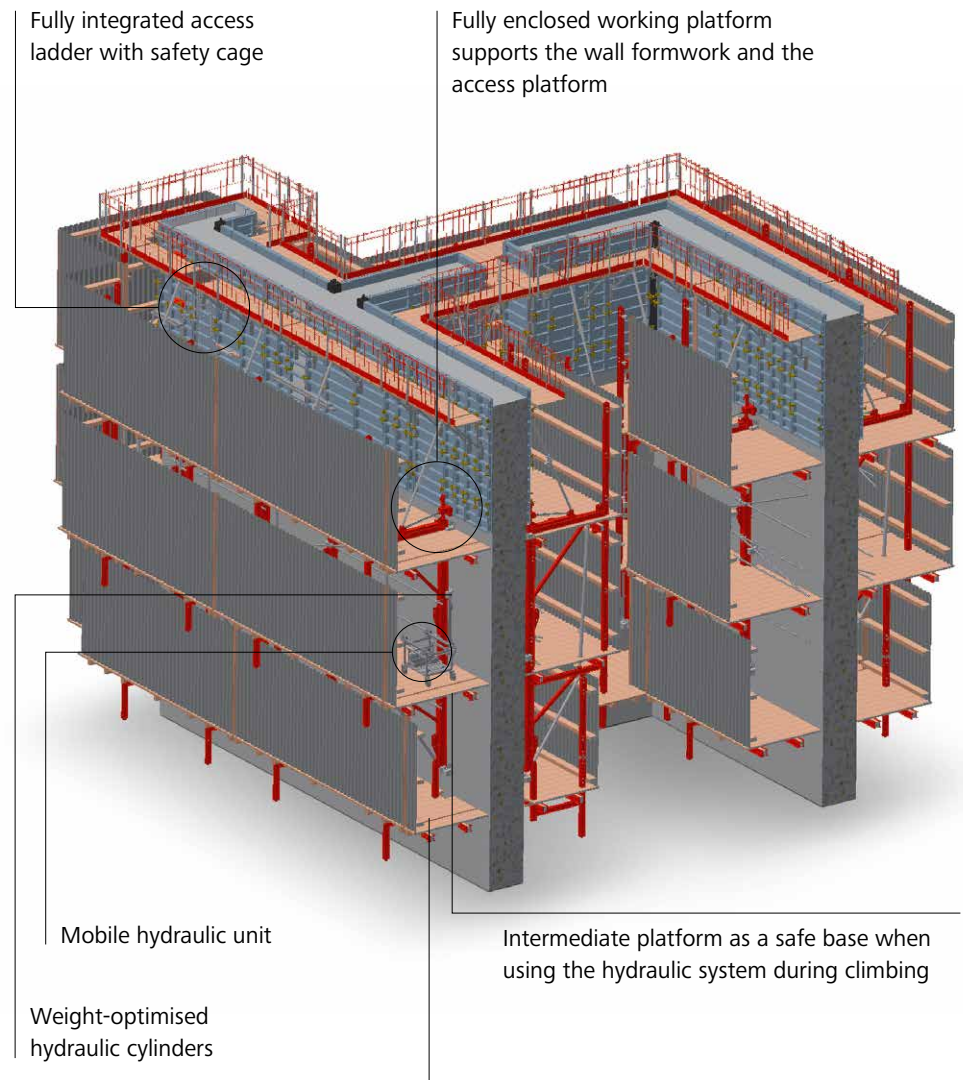

Easy to use: Trailing platforms can be flexibly attached to the guide rails in order to safely perform follow-up work.

i

Simply smart

- **Lifting process using hydraulics or by crane**
 - Provides for flexibility and efficiency
- **Free positioning of the guide rails up to 4.50 m**
 - Width covers a wide range of standard applications
- **High degree of safety**
 - Fully integrated access ladders with safety cages
- **Safe and efficient preassembly on the ground**
- **Delivery of preassembled transportable components possible**
- **Safe work in all weathers increases the productivity**
- **Ergonomic work thanks to weight-optimised components among other things**
- **All-in-one-solution**
 - MGC-H in conjunction with MGS-H provides for optimum safety and efficient construction processes



Firmly attached to the building at all times, during both the construction phase and the climbing phase.

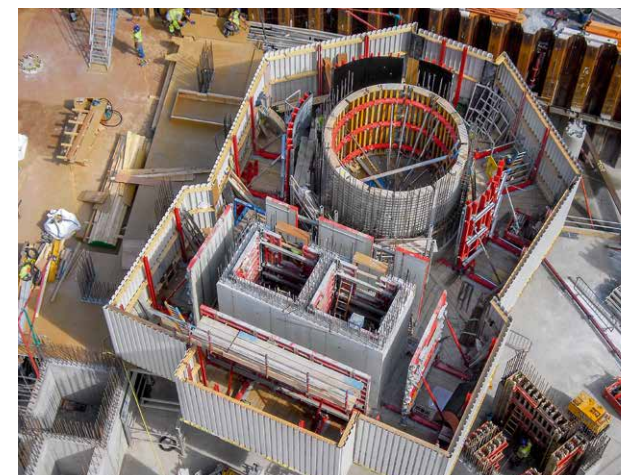

Even complex geometries with differently sized and offset structural elements can be mastered smoothly using the MGC-H guided climbing system.

The rail-guided MGS-H screen system

All-round protection at all heights

Rail-guided climbing, hydraulically or by crane.

The rail-guided MGS-H screen system (MEVA Guided Screens) provides all-round enclosure of the slab edges in the upper storeys and climbs hydraulically or by crane.

MEVA's guided screen system (MGS-H) encloses entire storeys of a building, especially during high-rise construction, irrespective of the height of the building. Maximum safety is guaranteed for the personnel during all phases of the work. Work can be performed in almost all weather conditions. The MGS-H remains connected to the building during the entire construction period, and can be attached to either the slab or the wall.

The MGS-H allows the sizes of the units to be chosen freely and perfectly adapted to suit the shape of the building. Even large-format units can be climbed quickly and safely in one lift. The screening is completely closed, optionally with cladding sheet (perforated or unperforated) or with various fabrics.

Safe and quick assembly

The MGS-H is safely and efficiently assembled on the ground or delivered completely preassembled to the construction site in order to avoid situations where time and space are critical.

Ergonomics

Besides safety, the focus is on ergonomics: weight-optimised hydraulic cylinders, a mobile hydraulic unit and the lightweight MGS-H guide shoe weighing only 20 kg make the assembly work easier.



Simply smart

- **System with individual units**
 - Flexible adaptation to the floor plan and the geometry
 - Free positioning of the guide rails
 - Economical solution for almost all buildings due to flexible widths
- **Safe and time-saving preassembly**
 - On the ground
 - Delivery of preassembled components possible
- **Ergonomic work thanks to weight-optimised components**
- **All-in-one-solution**
 - MGS-H in conjunction with MGC-H or MAC provides for optimum safety and efficient construction processes



Firmly attached to the building at all times to protect it against the wind, during both the construction phase and the climbing phase



Lifting process using hydraulics or by crane – high degree of flexibility and efficiency



Maximum flexibility and simplified suspension through folding mechanism and adjustable guide shoe

Maximum safety due to the completely enclosed building

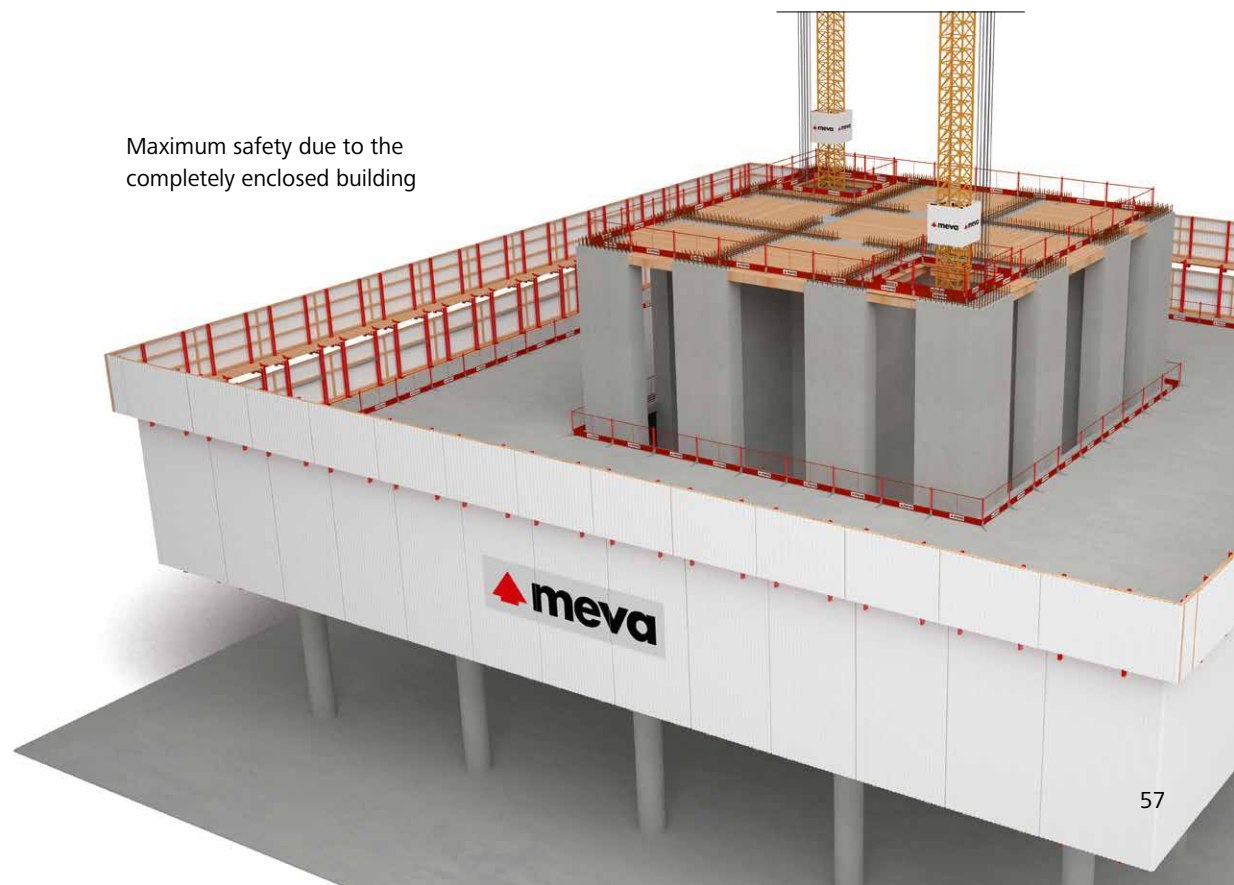

MAC automatic climbing system

Automatic climbing at great heights

Self-climbing, safe, quick, precise

The MAC automatic climbing system (MEVA Automatic Climbing) is the preferred solution for very tall buildings and when the strictest requirements are placed on safety. Together with the wall formwork, the MAC climbs as a fully enclosed unit without the use of a crane and thus ensures a maximum of work safety. The MAC has proven its worth during a great many high-rise construction projects such as the two highest office buildings in Switzerland, the Roche Tower buildings 1 and 2; the tallest building on the Indian subcontinent, the Palais Royale in Mumbai; or the One World Hotel in Singapore.

Safety, precision and speed

MAC combines safety and speed with precision. The complete unit can be raised by 4.5 m in only about 60 minutes and can be performed by small teams. In addition, the high-performance hydraulic system is protected by non-return valves in every cylinder.

Preassembly

Large parts of the MAC system can be preassembled upon request so that assembly at the construction site can be completed rapidly and efficiently.

Platform 1

provides a comfortable working area and sufficient storage space. In addition, the platform allows concrete placing booms to be integrated.

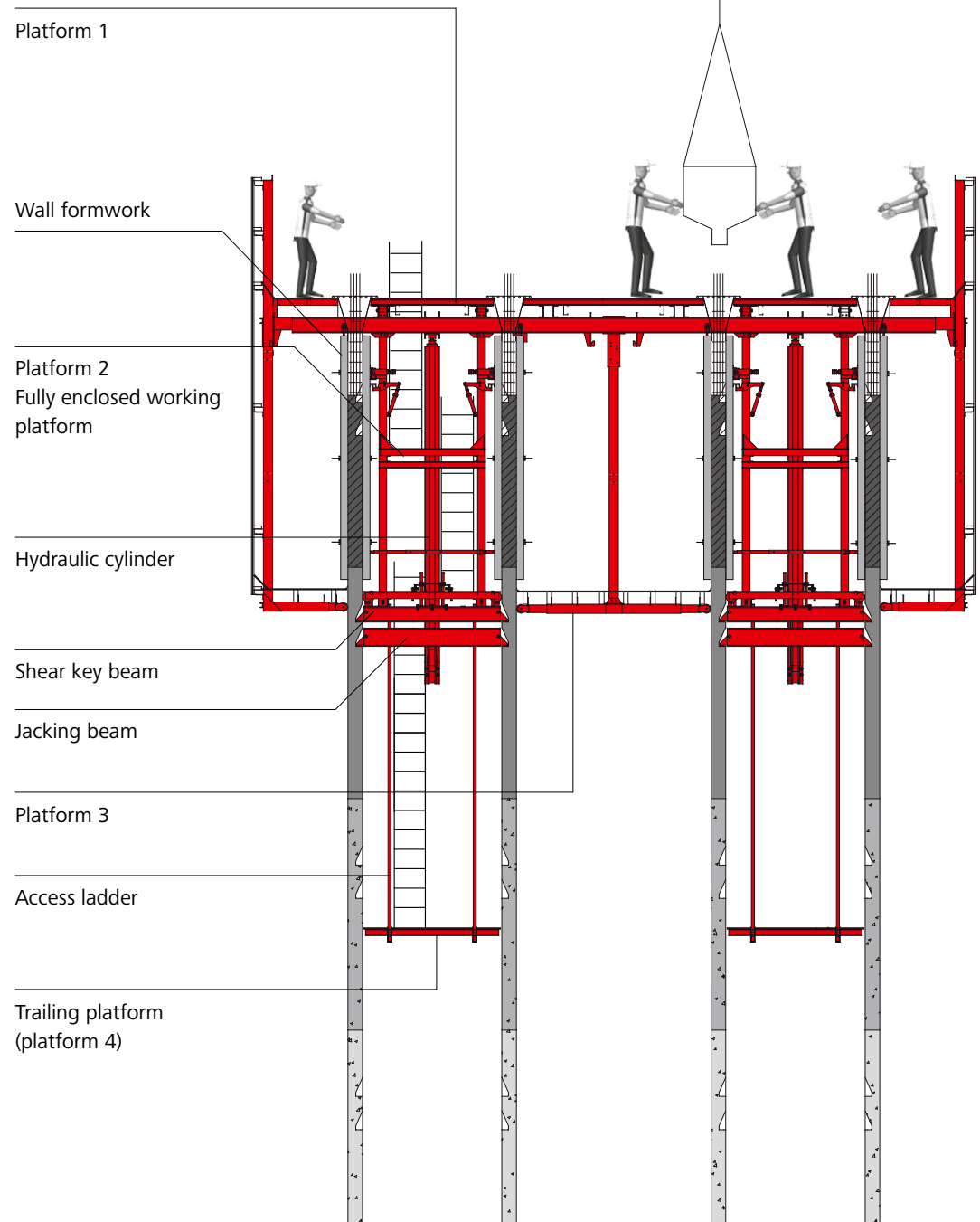



Simply smart

- **Crane-independent**
 - Guarantees speed and efficiency, especially at great heights
 - Crane is available for other tasks
- **Climbing process**
 - Tried-and-tested technology; improved efficiency; shorter construction time
- **High degree of safety**
 - Safe access thanks to integrated platforms and ladders
- **High-performance hydraulic system of the MAC automatic climbing system allows a stroke of 4.5 metres (20 t per cylinder)**
 - The 4.5 m lifting process takes only about 60 minutes
 - Climbs as a single unit
- **Just one day needs to be planned in for stripping, climbing and setting up the formwork. Depending on the duration of the boxout work, 4 days per cycle have already been achieved on numerous occasions.**
- **Additional trailing platforms for other tasks can make the use of an additional access system superfluous.**
- **Completely covered and closed working platform**
 - Protection against the effects of weather as well as comfortable working conditions, screening to block the outside view and also provide privacy protection
 - Construction schedule independent of the weather
 - Enables work to be performed independently on wall and slab
- **All-in-one-solution**
 - MAC in conjunction with MGS-H for optimum safety and efficient construction process

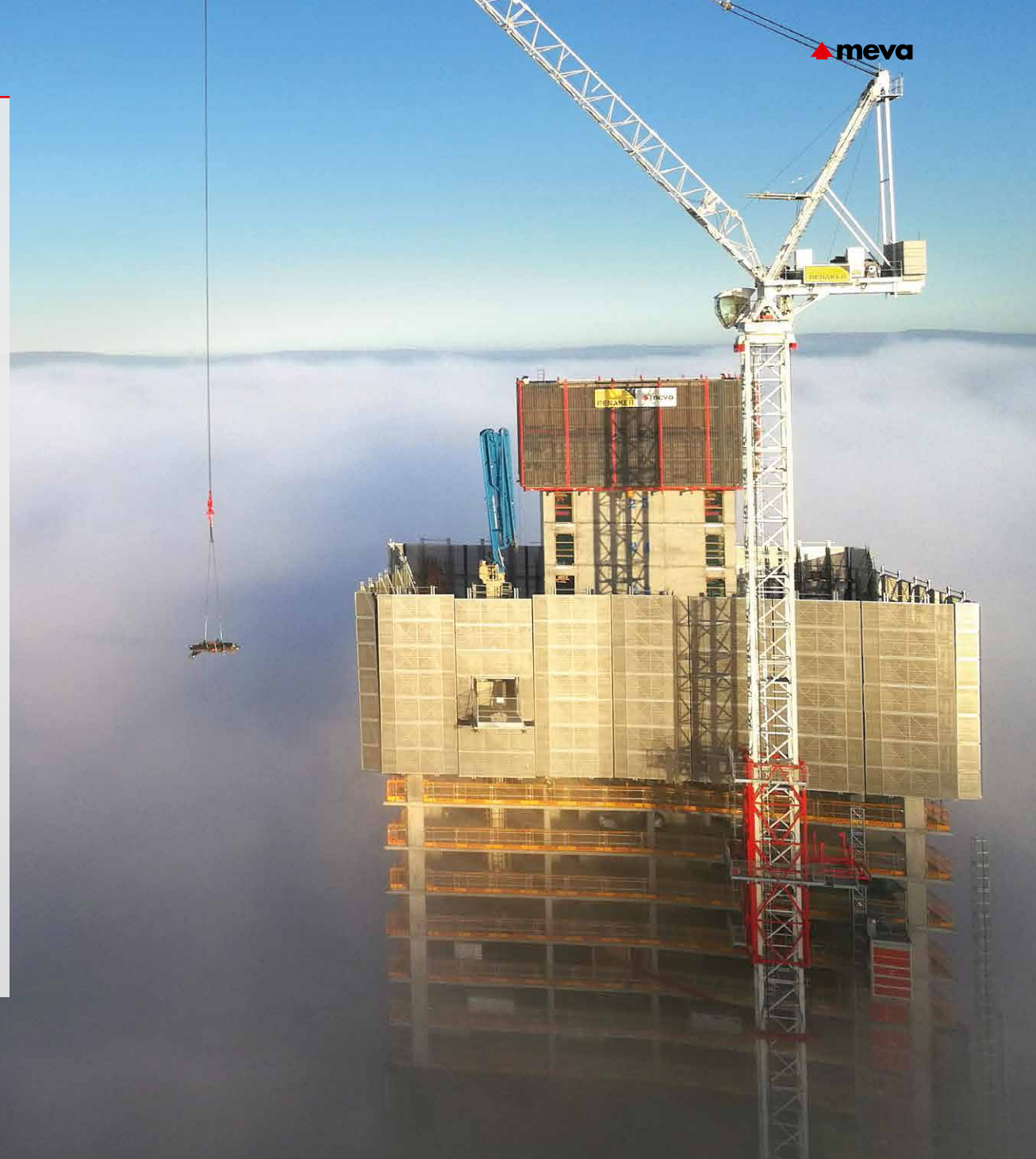

Special formwork – aluminium & steel

Well combined

A cost-effective combination

The combination of standard and special parts as well as the modification of standard parts is the efficient solution, inter alia, for

- Corner panels for wastewater treatment plants
- Special parts for inclined, curved walls
- Special panels for slabs
- Rectangular and circular formwork
- Special steel versions for tunnel construction

The MEVA assembly lock connects standard and special parts efficiently and in non-positive way.



Mobile tunnel formwork.

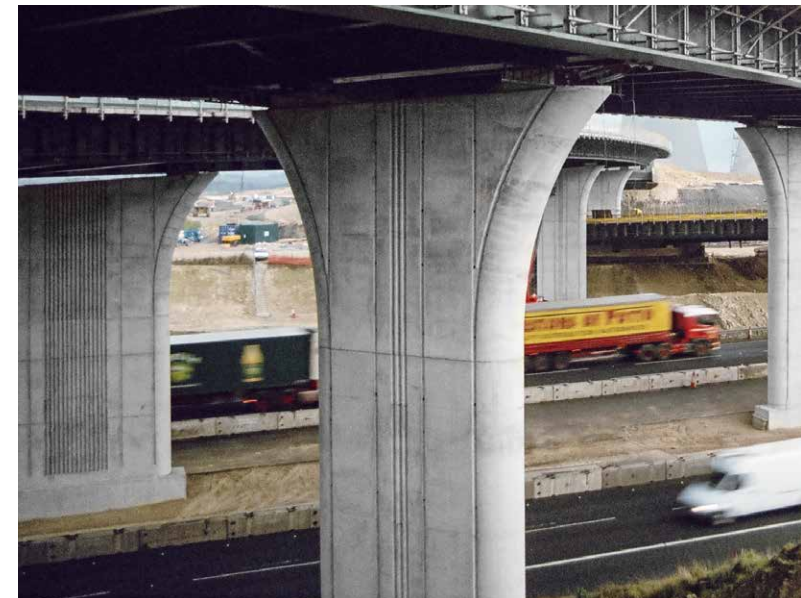

Special formwork can be produced for inclined and curved structures on the basis of the Circo circular column formwork. For example, at the Holmfild Exchange in the UK.

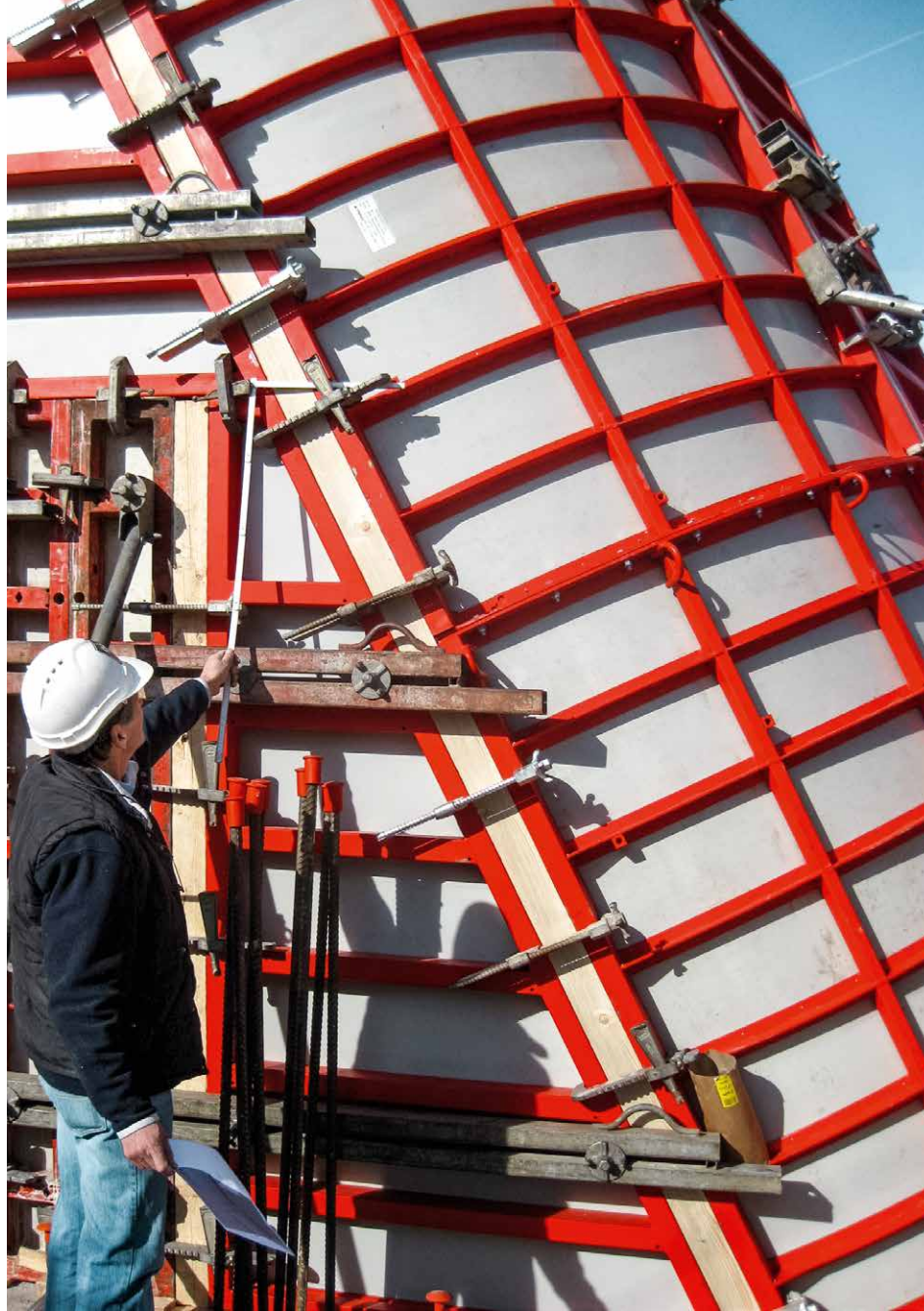

The openings developed to meet the corresponding requirements at this construction site convince through their cost-effectiveness when used a number of times.

Special formwork based on the Mammut wall formwork.



Services

Partnership from the very start

Making formwork solutions complete

The building sector, including its suppliers and affiliates, is facing ever tougher demands: for SMEs and global construction players alike, quality, timing and cost-effectiveness are crucial factors. That is why MEVA delivers comprehensive, integral service packages that far transcend the formwork product. Providing customers with end-to-end solutions that meet all needs and combine cost certainty with reliable planning is the bar we set for ourselves. This includes sophisticated formwork engineering services as well as specially designed assemblies that offer our customers a swift and dependable means of achieving their objectives.

With its brand promise – "Formwork. Simple. Smart." – MEVA occupies a unique position in the formwork market, in which first-rate products are underpinned by first-rate service offerings. Tailored to our customers' needs, these all-round service packages exhibit the much-appreciated flexibility and expert support that have now become MEVA's hallmark.

With our in-depth know-how and experience, we are permanently at hand to assist our worldwide clientele at every step in the design and construction process.



Simply smart

- **Consulting and planning**
- **Formwork rental**
- **Architectural concrete**
- **On-site services**
- **Technical support**
- **Digital tools**
- **Maintenance**
- **MEVA Academy**



Consulting

Finding the best solution for your project

To ensure the success of your project, our engineers, technicians and customer service staff are there from start to finish to assist you – both on a one-to-one basis and as a team – in all formwork-related matters.

Whether you are using BIM or CAD formwork drawings to plan your site, we will provide you with support services tailored to your particular needs. We are also present on site. And apart from offering a wealth of experience and know-how, our engineers, technicians and master formworkers are not afraid of getting their hands dirty when helping out.

- Project consulting
- Feasibility studies
- Co-ordination with construction planning, programming and site supervision
- Optimisation of sequencing and pour cycle planning
- On-site service, including instruction and supervision
- Regular project meetings
- Cost-effective custom fabrication and small-run production of special components
- Special solutions and innovative formwork concepts

BIM

Going digital together

Working in tandem with our partners BIM² GmbH and Build Informed GmbH, we will help you navigate the digital revolution.

Our consulting, training, modelling and development services cover all aspects of digitalisation and building information modelling. Apart from generating customer-specific added value, we will also put in place efficient and transparent processes. Our services specifically comprise:

- Consulting on development of digitalisation strategies
- Implementation of BIM methods in design and construction
- Creation of building component libraries and templates, and definition of necessary standards
- Staff training
- Creation of as-built models based on existing documentation
- Process optimisation using human-computer interaction technology (software development)
- and much more

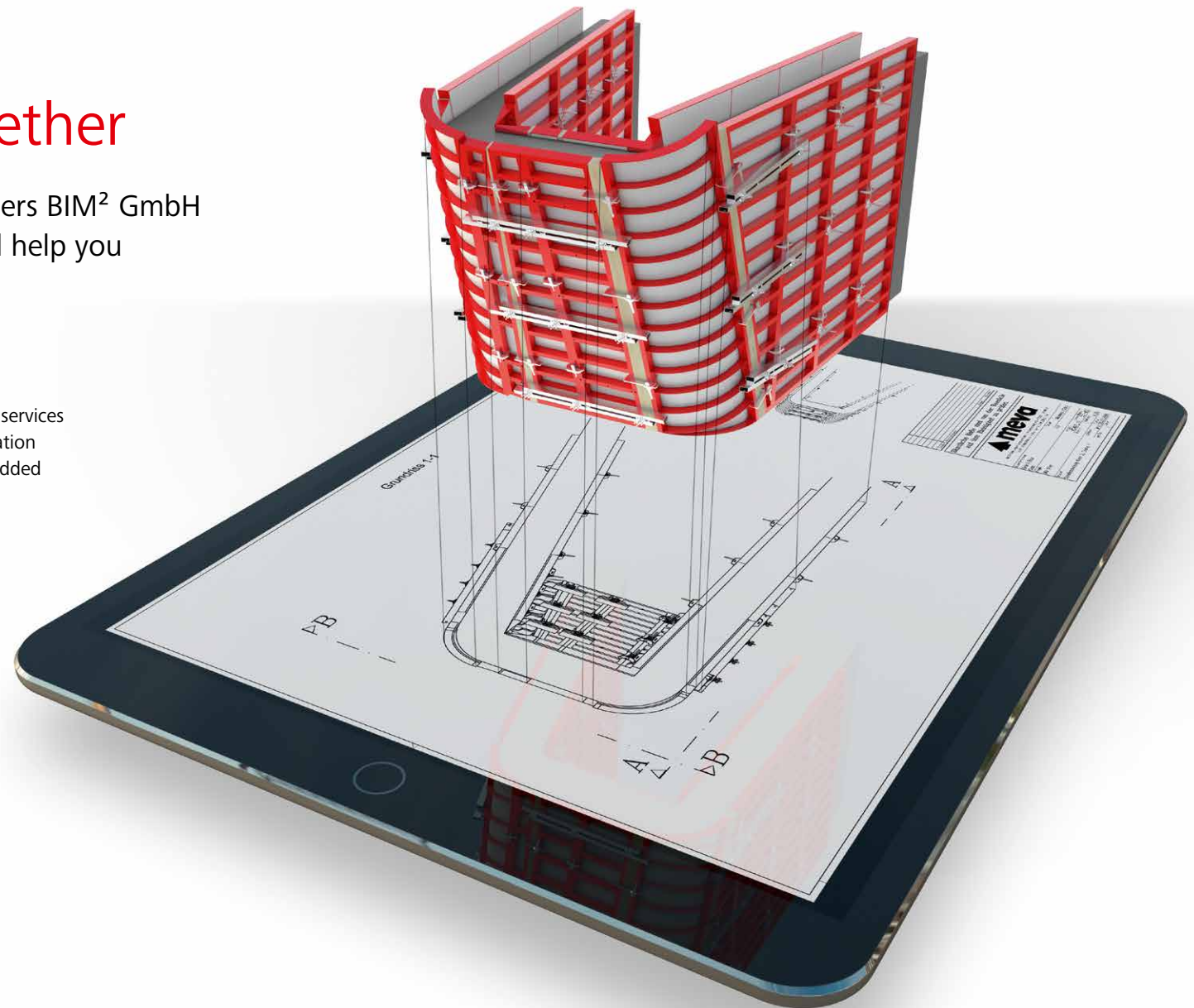

Design and planning

Success can be planned

Helping you keep a firm grip on your processes.

We use state-of-the-art CAD tools to prepare formwork drawings with detailed material schedules or we work with seamlessly interfaced systems to support your BIM project.

- Formwork and sequencing solutions proposed as early as the tendering stage
- Detailed formwork and sequencing proposals, including any suitable alternative offers, with cost breakdowns as a tender for our customers
- Formwork contract planning, covering pour cycles, choice of system, quantity measurement and detailing
- Architectural concrete consulting
- Advice and support, also on site, regarding issues such as fresh concrete load capacity and concreting procedures
- Preparation of assembly drawings, planning of assembly procedures and on-site supervision
- Formwork design and production planning in 2D or 3D
- Implementation of BIM methods in design and construction
- Preparation of verifiable structural calculations

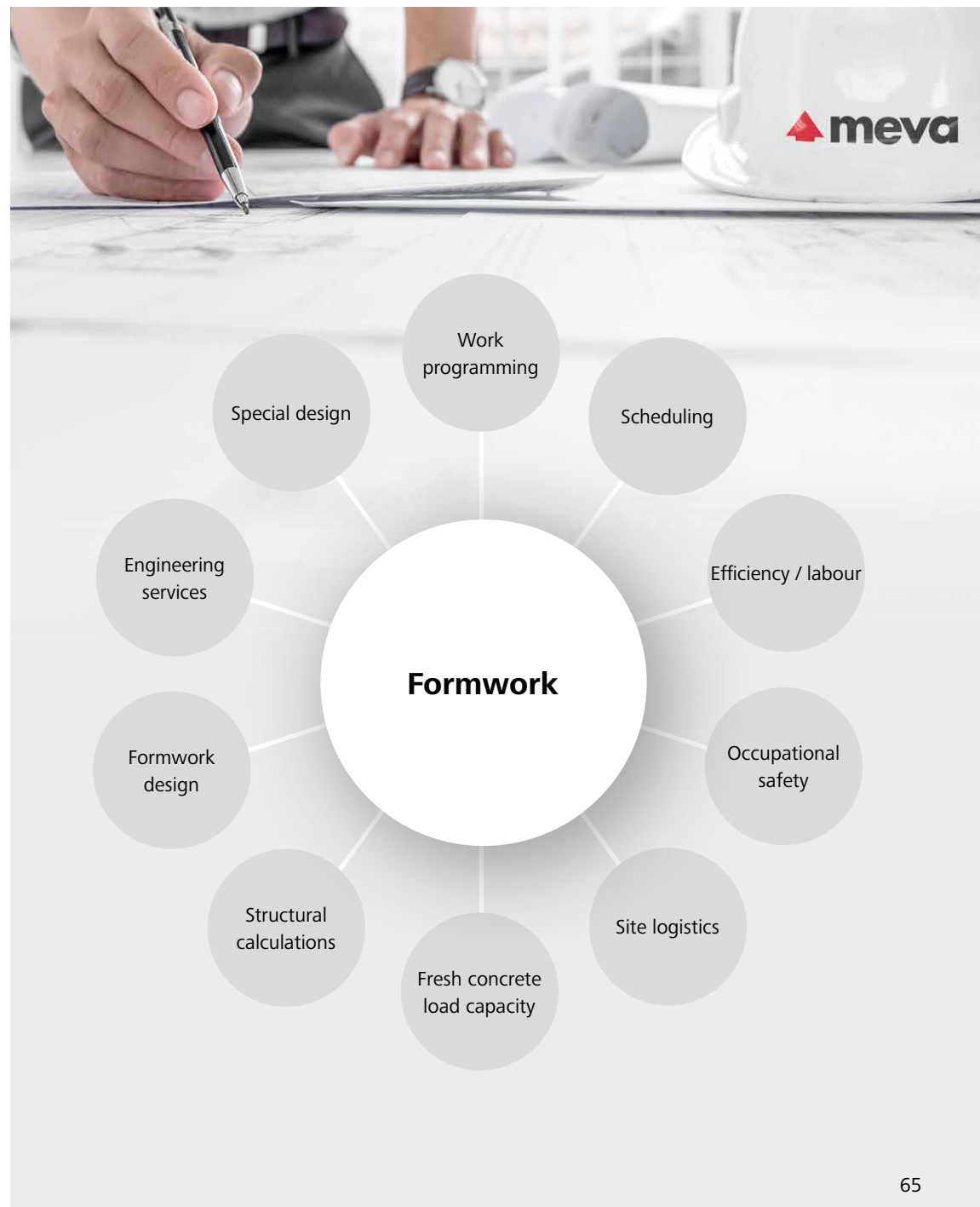

Digital tools

Speeding up progress on site

MEVA uses smart tools to promote safety and deliver prompt answers to all questions that arise during the concreting works.

MEVA me app – innovative, intelligent

Our forward-looking digital technology includes the MEVA me app, which will provide you with a direct link to the company's digital nerve centre. Whether you need product information or wish to use our smart tools, the intelligent start menu will automatically reconfigure itself in line with the content you access most frequently. The current edition of FormworkPress with the latest facts and trends is also available in e-paper form for you to read at leisure. The app focuses, in particular, on presenting and demonstrating MEVA's formwork systems.

It is available from the Android and iOS app store.

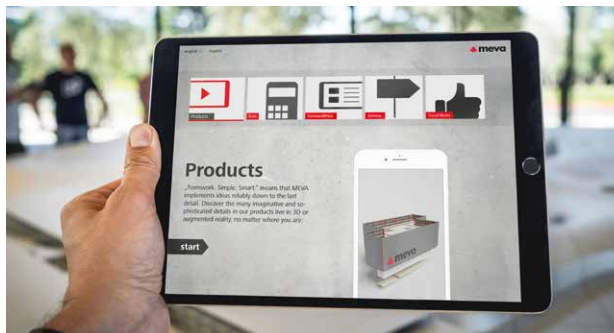

EuroSchal® design and planning software

EuroSchal® offers a fast and simple means of calculating the formwork requirement for your projects and simplifies the preparation of material schedules, formwork drawings and pour cycle plans. Rationalisation, shorter working times, cost savings – opt to use EuroSchal® on your sites and all these benefits will be yours.



Architectural concrete

Turning the possible into reality

For architectural concrete solutions, sending MEVA an early enquiry will pay dividends. Drawing on our experience, we will assist you in all aspects of technical feasibility in realising the architectural concept.

We will partner you in singling out the best formwork solution for the desired result, e.g. using preformed alkus facings with special components or intelligently deployed standard panel assemblies.

Panelised formwork, either with or without facing sheets, can meet wide-ranging fair-faced concrete requirements while delivering neat joint and tie-hole patterns.

Even after heavy use, the alkus all-plastic facing, which is fitted as standard in all MEVA formwork, achieves a consistently high-quality concrete finish. The non-absorbent facing serves to produce uniformly low-void concrete with a smooth, non-friable surface requiring a minimum use of release agent.



Formwork rental

Planning certainty, investment flexibility

MEVA provides options to promote transparent costing and the economical implementation of your construction project without any additional investment risks. Make sure you take advantage of the various service flat rates, which are adaptable to your requirements.

MEVA rental

The MEVA rental service allows you to remain flexible, without tying up capital or taking investment risks. By hiring the formwork you need, you will benefit from consistently high product quality, meeting GSV (German Concrete Formwork Quality Protection Association) standards, and at the same time eliminate the risk of redundant capacity. You will also have the opportunity to try out front-line products and solutions on site. You can rely on our logistics team to ensure that everything runs smoothly: MEVA's worldwide logistics centres serve to minimise transportation distances and speed up formwork delivery to and collection from the site.

All-in RentalPlus package

RentalPlus offers you cost certainty from the very outset. Apart from rental and logistics, all ancillary services, such as cleaning and repairs, are covered. Only lost parts and irreparable damage are separately invoiced. For these services, MEVA charges a monthly or overall flat rate based on the total value of all rented inventory. The RentalPlus package is separately agreed on a project-specific basis.

MEVA Rental Info for your rental operations

MEVA's Rental Info service offers you support and transparency for your rental operations. It allows you to select rental data, inventory details and summaries according to specific criteria, as required for your own particular processes. This will give you a clear overview and full control of your rental project and transactions from beginning to end – which, in turn, will reduce your administrative effort and simplify your cost planning. Rental Info services can be agreed with your MEVA contact.

RentalPlus benefits

- Complete final cleaning after return, thereby eliminating debates about deviations from the delivered condition and extra charges
- Function testing
- Any necessary repairs to all supplied formwork and shoring tower components
- All checks on safety and performance
- All necessary welding and straightening works
- Replacement of damaged horizontal and end braces for panelised formwork
- Plugging of drill holes in facings
- Replacement of facing sections (for wall formwork systems)
- Damaged wooden beams are cut down to the next lower standard size

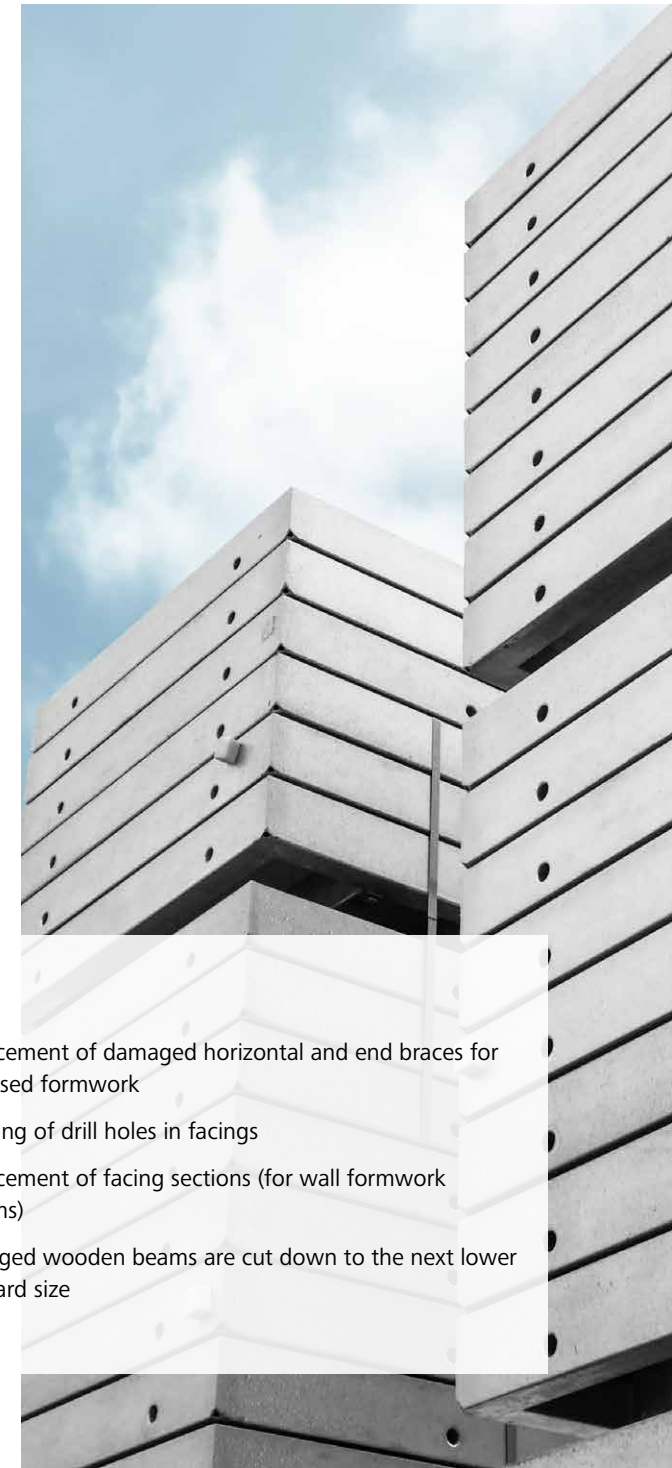

Maintenance of customer formwork

Preserving the value of your assets

Regardless of manufacturer, your formwork products are regularly subjected to rigorous testing by the rough conditions on construction sites. This is where we step in.

Apart from producing formwork, MEVA will also assist you in preserving the value of your investments. After all, the longer the service life of purchased formwork, the greater the cost benefit.

On request, we will also treat formwork from other manufacturers, subject to its suitability



You can rely on us wherever you are.

With 40 offices on 5 continents, we are
on the spot wherever you need us.

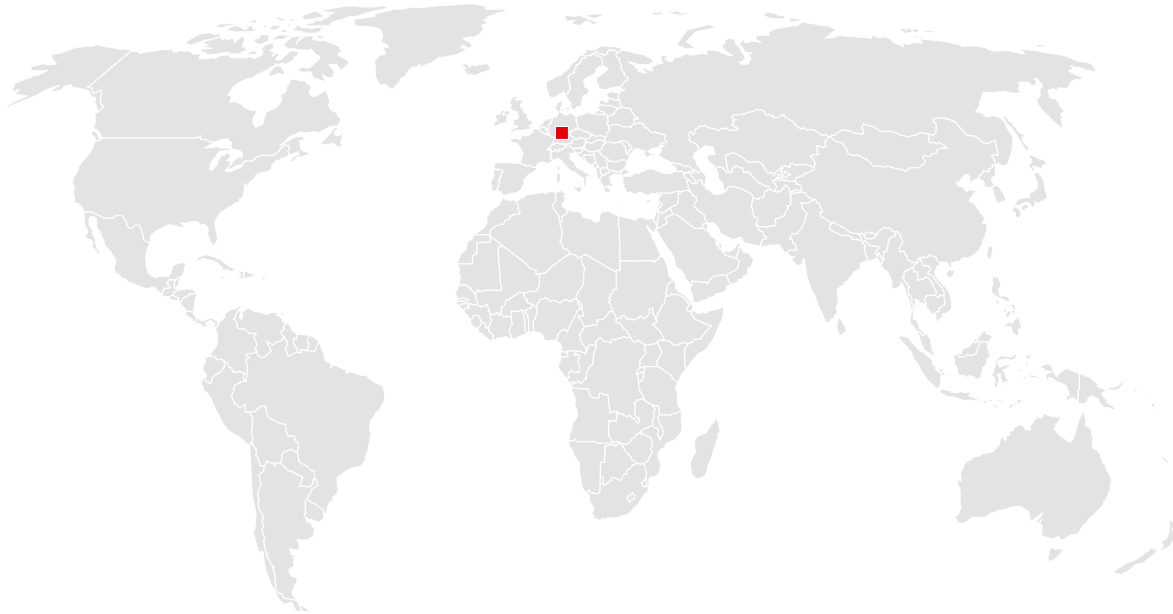

Headquarters (Germany)

MEVA Schalungs-Systeme GmbH
Industriestrasse 5
72221 Haiterbach
Tel. +49 7456 692-01
Fax +49 7456 692-66

info@meva.net
www.meva.net

Subsidiaries/international bases

AE-Dubai	Tel. +971 4 8042200	LATAM	latam@meva.net
AT-Pfaffstätten	Tel. +43 2252 20900-0	LU-Rodange	Tel. +352 20 283747
AU-Adelaide	Tel. +61 8 82634377	MA-Casablanca	Tel. +212 684-602243
BE-Landen	Tel. +32 11 717040	MY-Perak	Tel. +60 12 5209337
BH-Riffa	Tel. +973 3322 4290	NL-Gouda	Tel. +31 182 570770
CA-Toronto	Tel. +1 416 8565560	NO-Oslo	Tel. +47 67 154200
CH-Seon	Tel. +41 62 7697100	PA-Panama City	Tel. +507 2372222
DK-Holbæk	Tel. +45 56 311855	PH-Manila	Tel. +63 998 5416975
FR-Sarreguemines	Tel. +33 387 959938	QA-Doha	Tel. +974 4006 8485
GB-Tamworth	Tel. +44 1827 60217	SG-Singapore	Tel. +65 67354459
HU-Budapest	Tel. +36 1 2722222	US-Springfield	Tel. +1 937 3280022
IN-Mumbai	Tel. +91 22 27563430		



MEVA Schalungs-Systeme GmbH

Industriestrasse 5 Tel. +49 7456 692-01
72221 Haiterbach Fax +49 7456 692-66
Germany info@meva.net

www.meva.net