



MEVA Packaging Guidelines

General Packaging and Shipping Regulations

Issue: 27/07/2023

Version: V.2

MEVA Schalungs-Systeme GmbH

Industriestraße 5
72221 Haiterbach
Germany
www.meva.net



Contents

Purpose of the regulations	3	Permissible loading aids	6
Problem	3	→ Stacking rack	6
Purpose	3	→ Storage box	6
Scope of the regulations	3	→ Euro pallet	6
Delivery address	3	→ One-way pallet	6
Goods-receiving hours	4	→ Euro pallet cage	7
Packaging material and loading aids	4	→ Wooden crates	7
General information	4	→ Additional information	7
Permissible packaging material	4	Forming loading units	9
→ Plastics	4	Technical condition of the packaging	10
→ Shrink and stretch film	4	Exchangeability of the loading aids	10
→ Bags and sacks made of film	4	Completeness of the shipping documents	13
→ Paper and cardboard	4	Labelling and marking	14
→ Wood	4	Handling of incorrect packaging	15
→ Polystyrene	5	Unloading	15
→ Fill material	5		
→ Straps	5		
→ Edge protectors	5		

Purpose of the regulations

Problem

Due to globalisation and technological advances, the volume of international trade is increasing. Nowadays, cross-border trade is no longer a rarity for most companies.

Purpose

The purpose of the General Packaging and Delivery Regulations is to ensure that our suppliers are familiar with the requirements and their responsibilities. In addition, the intention is to improve the process reliability in the incoming and outgoing goods departments. The consistent observance and implementation of these guidelines will ensure smooth processes for all parties and will protect the suppliers against potential complaints or negative supplier evaluations. Furthermore, compliance with the packaging regulations will avoid extra costs caused by repacking work, additional checks, relabelling and relocation of the goods.

There are a large number of different transport options to which, to a certain degree, different packaging regulations apply. Furthermore, unnecessary packaging material represents a waste of resources.

MEVA Schalungs-Systeme GmbH is dedicated to environmental protection. For this reason, resources and packaging material should be used sustainably, efficiently and effectively. Additional costs that arise due to non-compliance will be borne by the suppliers. MEVA reserves the right to agree product-specific packaging regulations with the supplier if the supplier is not able to implement the General Packaging and Shipping Regulations. Deviations from these General Packaging and Shipping Regulations must be expressly agreed in writing with MEVA. If product-specific packaging regulations have not been agreed with MEVA, the General Packaging and Shipping Regulations apply.

Scope of the regulations

Delivery address

The General Packaging and Shipping Regulations apply to delivery to the national MEVA factories as well as to the international subsidiaries. Incoming goods will only be accepted on the factory site at the correct delivery address during the applicable goods-receiving hours.

In the event of non-compliance, it will not be possible to accept incoming goods and the delivery will be refused. All information regarding delivery address, goods-receiving zones and the factory can be found in the order or the delivery note.

Goods-receiving hours

Address	Goods-receiving hours
Factory I Industriestraße 18 72221 Haiterbach Germany	Monday to Friday 07:00 – 17:00
Factory II Kurze Umbrüche 9 72221 Haiterbach Germany	Monday to Friday 05:00 – 22:00
Factory III Lange Umbrüche 23 72221 Haiterbach Germany	Monday to Friday 07:00 – 15:30
Berlin branch Zeppelinring 4 15749 Mittenwalde Germany	Monday to Friday 05:00 – 22:00

Packaging material and loading aids

General information

All packaging material used must comply with MEVA Schalungs-Systeme GmbH's General Packaging and Shipping Regulations as well as the current statutory stipulations that apply in Germany and the European Union (packaging and shipping regulations in accordance with sections 407 ff. of the German Commercial Code (Handelgesetzbuch)). In particular, the currently valid statutory limiting values for the content of heavy metals must not be exceeded. If the goods to be packed are to be delivered to countries

outside the European Union, the statutory regulations of the country in question are to be observed. **All loading aids used for shipping to MEVA must comply with the dimensions defined in these General Packaging and Shipping Regulations and be in faultless, undamaged and clean condition. Contamination of any nature will not be accepted.**

Contaminated goods will be returned to the supplier or repackaged at the supplier's expense

Permissible packaging material

→ Plastics

Only PE (polyethylene), PP (polypropylene) or PET (polyethylene terephthalate) may be used. In order to allow targeted recycling, the quantity of material used must be as low as possible. The use of PVC (polyvinyl chloride) is prohibited.

→ Shrink and stretch film

These must always be made of PE (polyethylene).

→ Bags and sacks made of film

These must always be made of PE (polyethylene).

→ Paper and cardboard

These must be free of substances that have a negative impact on the paper production process.

→ Wood

For all packaging material made of wood that are transported from overseas (“wet borders”), compliance with the IPPC standard (International Plant Protection Convention), ISPM 15 (International Standards For Phytosanitary Measures) is mandatory.

When shipping wooden packaging overseas, the regulations of the recipient country must be observed. Proof of compliance is further underlined by means of the stamp.

→ **Polystyrene**

Polystyrene may only be used for moulded parts. The use of polystyrene chips is not permitted.

→ **Fill material**

Only corrugated cardboard, paper or bubble wrap may be used as fill material.

→ **Straps**

Straps may only be made of PP (polypropylene) or PET (polyethylene terephthalate). The use of metal straps cannot be avoided for bundles and may be used for certain products in accordance with MEVA Packing Instructions.

→ **Edge protectors**

The use of edge protectors is permitted. These can be made of cardboard and plastic.

Permissible loading aids

→ Stacking rack

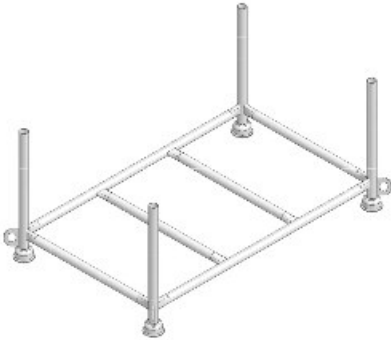

Coated. Used to store and transport props, wooden girders, etc.

Ref. no.	27-000-20
Dimensions	1700 x 1100 x 780 mm
Weight	34.5 kg
Maximum capacity	For longitudinal loading up to 1,500 kg For transverse loading up to 650 kg

→ Storage box

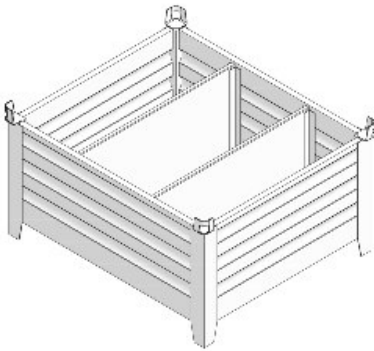

Coated. Stackable. Can be used to store assembly locks, anchoring material and other accessories. With removable partitions and a hinged front cover. Stacking height 60 cm.

Ref. no.	27-000-10
Dimensions	1250 x 1100 x 650 mm
Weight	102 kg
Maximum capacity	Gross weight up to 2,000 kg

→ Euro pallet



In accordance with DIN 13698-1; UIC standard 435-2
In accordance with exchange criteria according to EPAL

Dimensions	1200 x 800 mm
Weight	Approx. 24 kg
Maximum permissible	Gross weight for each packaging unit up to 900 kg Height up to 100 cm

→ One-way pallet



Dimensions	1200 x 800 mm and 600 x 800 mm
Weight	Approx. 13 kg
Maximum permissible	Gross weight for each packaging unit up to 900 kg Height up to 100 cm

→ **Euro pallet cage**



In accordance with DIN 15155; UIC standard 435-3
In accordance with exchange criteria according to EPAL

Dimensions	1240 x 835 x 970 mm
Weight	Approx. 70 kg
Maximum permissible	Gross weight up to 1,400 kg

→ **Wooden crates**



Dimensions	1200 x 800 x max. 1000 mm
Weight	Approx. 40 kg
Maximum permissible	Gross weight for each packaging unit up to 900 kg

→ **Additional information**

The base size of every carton must be compatible with the dimensions of the Euro pallet. The following base sizes are permissible for cartons:

- 80 x 120 cm
- 80 x 60 cm
- 60 x 40 cm
- 30 x 40 cm

- 20 x 30 cm

The carton dimensions are to be selected so that it is completely filled. The packaging unit must always be specified. One transport label is to be attached to each pallet for homogeneous shipments. For mixed shipments a packing list is required for each packaging unit.

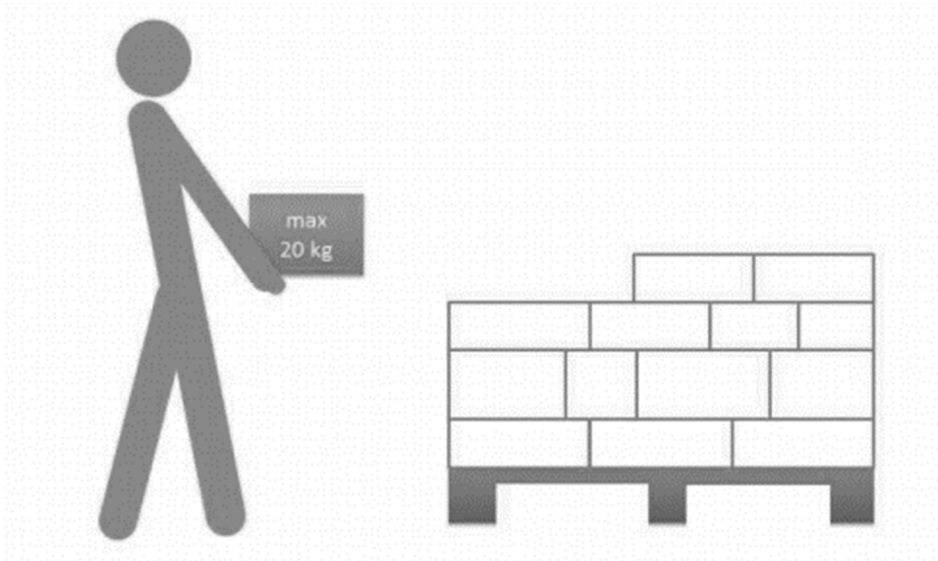

Packages that are lifted manually should not weigh more than 20 kg. Packages that weigh more than 20 kg must always be delivered on pallets.

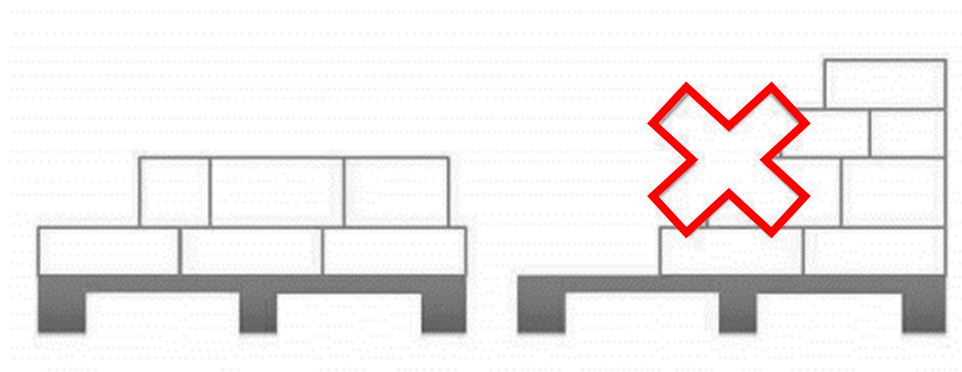

The load carrier is to be packed so that the weight is uniformly distributed over the surface. If this is not possible, this must be visibly marked.
(Caution: offset centre of gravity!)

Forming loading units

If a loading unit is made up of smaller packaging units, these must correspond to the dimensions specified in the previous section. It must be possible to stack the loading unit.

The individual packaging units must be secured to ensure that they cannot shift when forming loading units. If a complete layer cannot be formed due to the quantity to be delivered, this layer must be supplemented with permissible filler material.

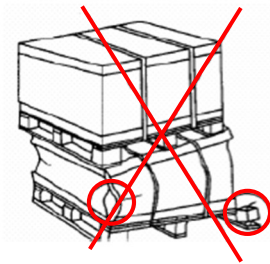

falsch

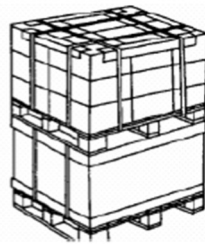

richtig

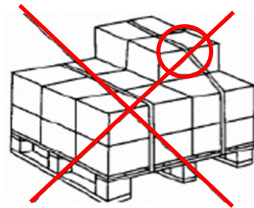

falsch

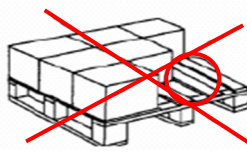

falsch

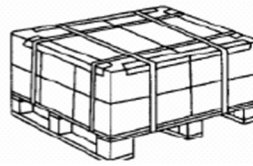

richtig



falsch

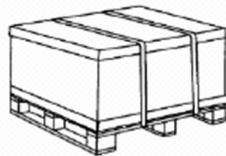

richtig



Technical condition of the packaging

The load is to be secured on a loading unit (pallet) using the following aids:

- Pallet covers (slip lids)
- Shrink hoods
- Stretch film
- Strapping using plastic straps (2 straps or 4 straps) in conjunction with edge protectors

The basic dimensions of the loading unit (1,200 x 800 mm) must not be exceeded by the packaged goods and other loading units. Loading units are to be secured so that the packaged goods cannot shift during transport.



Edge protectors must be used to prevent the straps cutting into the cartons. If part of the load is removed, it must be ensured that the residual load remains stable.

The packaging must protect the goods against humidity, dirt and dust. The load carrier – especially the contact surfaces for the load – must be clean and in perfect condition. Used packaging material (e.g. cartons, film, etc.) must not be used.



Exchangeability of the loading aids

The exchange of loading aids is governed by the provisions specified in UIC leaflet 435-4. Non-exchangeable loading aids will be documented

separately upon delivery and disposed of at the supplier's expense. Interim storage of non-exchangeable loading aids is not possible.

Examples of non-exchangeable Euro pallets

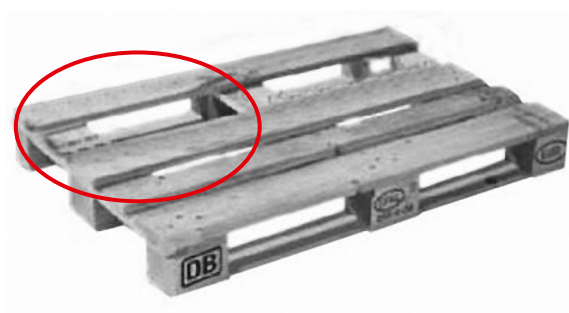

A board is missing.

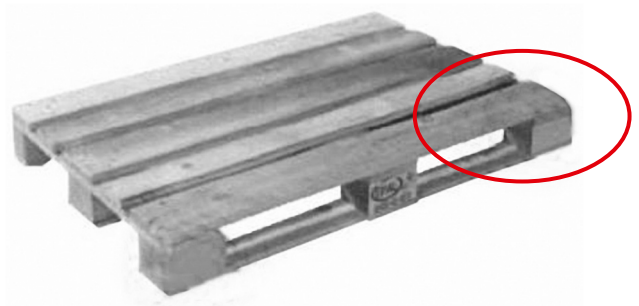

Poor general condition, for example rotten material, pronounced splintering, boards too thin, blocks too narrow. The marking "EUR" on the right and the marking "EPAL" on the left are missing.



A block is missing or split in such a way that more than one nail shank is visible.

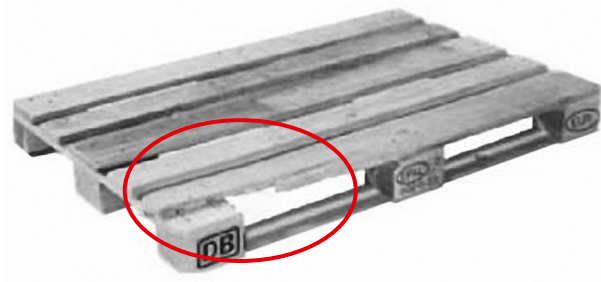

A bottom or deck board is splintered in such a way that more than one nail shank is visible.

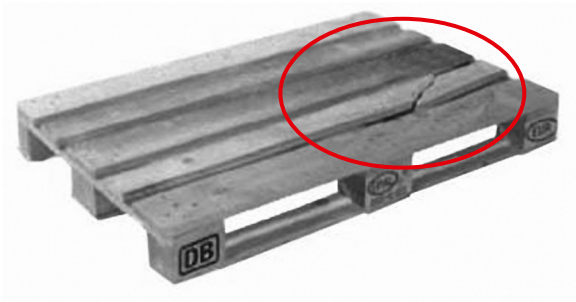

A board is broken transversally or diagonally. A bottom or deck board is splintered in such a way that more than one nail shank is visible.

Examples of non-exchangeable pallet cages

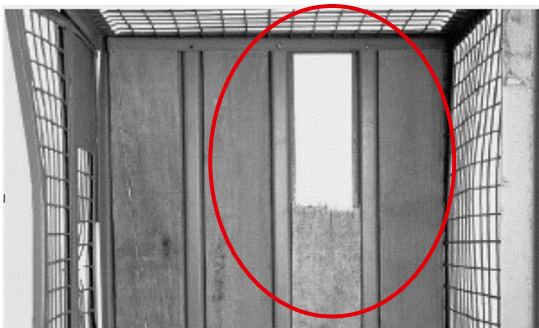

The base frame or feet are bent in such a way that the pallet cage no longer stands evenly on four feet or can no longer be safely stacked. Here: a board is missing or has broken off.

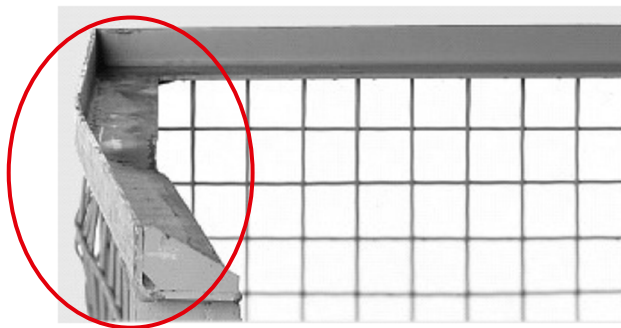

The stacking frame or the corner posts are deformed.

The tubular steel mesh is torn in such a way that the wire ends protrude inwards or outwards (one mesh per wall may be missing).

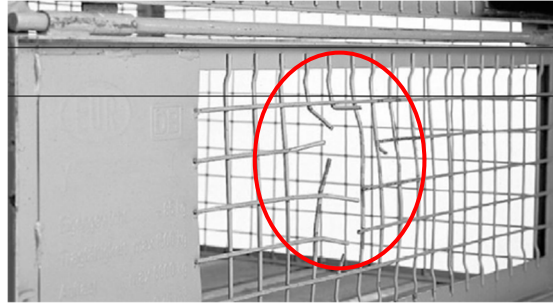

Completeness of the shipping documents

→ Accompanying documents

The forwarder must be supplied with correct freight and accompanying documents.

→ Waybill

The forwarder must receive a waybill for every shipment. The waybill must include the following details about the shipment:

- Consignor's (supplier's) address with supplier number
- Receiving address at MEVA Schalungs-Systeme GmbH
- Order number assigned by MEVA Schalungs-Systeme GmbH
- Number of packages in the shipment
- Total weight of the shipment
- Date of deliver or dispatch

→ Delivery note

An original delivery note must be included with every shipment. The delivery note must be in a clearly visible delivery note pocket attached to the end face of the package. If a shipment is made up of several packages or pallets, the content of every load carrier is to be listed in a packing list.

The delivery note must include the following information about the order:

- Order number
- Supplier and supplier's address
- Part number with revision status
- Article name
- Delivery quantity
- Partial deliveries must be noted on the delivery note.

If the article is handled in batches, the batch number must also be included.

→ Packing list

If a shipment is made up of several packages or pallets, a packing list must be included containing the following information about the order:

- Package or pallet number
- Reference number
- Quantity of items
- Quantity and content of the individual packages

This information must also be included on the labels of the individual packages. The contents of the individual packages must correspond to the labels.

Labelling and marking

To avoid misunderstandings and ensure smooth and rapid processing in the incoming goods department, the goods must be reliably and unequivocally labelled. Incorrect, ambiguous or missing labels or documentation result in significant disruptions. For this reason, we reserve the right to charge the causer a flat-rate fee of €100 for each delivery item. In addition, repeated violations will be taken into account in the supplier evaluation. The accompanying documents and the invoice must include the order number, the part number, the delivery address, the place of dispatch, the quantity and type of packages, the gross and net weights, and, for bulky shipments, also the volume. The weight of the pallet cages, flat pallets, etc. is not included in the chargeable weight.

Every package must have a label with at least the following information so that it can be clearly identified:

- Supplier's name
- Order number
- Part number with revision status
- Article name
- Quantity of the article in the package

Every workpiece that is classified as being subject to compulsory labelling must be permanently labelled. Upon delivery, all parts must be correctly labelled without exception for the purpose of clear identification. The use of typewritten labels is recommended. The labelling must not influence the cleanliness and quality of the parts. In particular, it must be ensured that all labels can be removed without residue. The label must be clearly visible at all times and in any position.

Zum Beispiel:

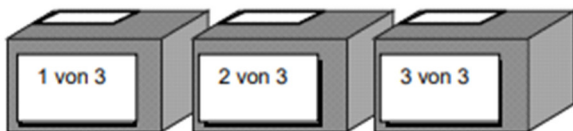

richtig

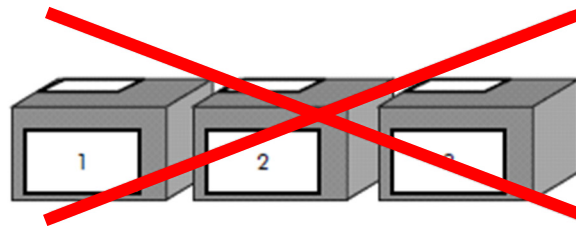

falsch

Handling of incorrect packaging

The supplier shall be liable for damage caused by incorrect packaging. The goods must be delivered without damage in the specified manner, quantity and quantity. This also applies to correct packaging. If an obvious packaging fault is determined when the goods are delivered, MEVA reserves the right to reject the goods partially or completely or to accept the goods subject to the proviso that the supplier will be charged for any additional costs.

Legal action will be taken in the event of defective performance of contractual obligations. If the goods are to be returned and if by way of exception we have agreed to bear the shipping costs, we reserve the right to select the means of transport. The right of rejection and the right to invoice the extra costs also apply to hidden defects that are only discovered at a later point of time in the material handling process.

Unloading

To guarantee the safety of our employees during unloading and onwards transport of the goods, it is vital that the goods correspond to the specified dimensions, weights and bundle sizes. In addition, the material must be adequately secured to ensure that the bundle does not come undone during loading. The forks require at least 10 cm under the material in order to be able to lift the goods.

The supplier or the forwarder is responsible for placing load boards under the material.

If our employees are not able to unload the goods for technical reasons or due to safety concerns, the material will be returned at the supplier's expense.